

Foreword

Air conditioners are units that should have the professional technicians do the installation for you.

This Instruction Guide is the universal-purpose version for the models of split wall-mounted air conditioners manufactured by our Co. The appearance of the units that you purchase might be slightly different from the ones described in the Guide, but it does not affect your proper operations and usage.

Please read carefully the sections corresponding to the specific model you choose, and keep the Guide properly so as to facilitate your reference at later time.

CONTENTS

Selection of installation positions for indoor unit	1
Selection of installation positions for outdoor unit	2
Installation fixture of indoor unit	3
Installation fixture of outdoor unit	4
Ordinary pipelines connection & Air purging	4
Pipelines connection for Split type quick coupler model	6
Pipelines connection for Whole-Unit type quick coupler model	7
Connection of power cable	8
Finishing touches and test running	8
Is the unit installed correctly?	9
Self diagnosis functions	10
Quick connector installation instruction	11
Installation Guide	12

【Selection of installation positions for indoor unit】

- To be installed at the position where the air delivered from the unit can reach every corner of the room;
- To avoid being affected by the outdoor air;
- To avoid blockage to the air inlet or outlet of the unit;
- To avoid too much oil smoke or steam;
- To avoid possible generation, inflow, lingering or leakage of flammable gases;
- To avoid high-frequency facilities (such as high frequency arc welders, etc.);
- To avoid the places where acid solutions are frequently used;
- To avoid the places where some special sprayers (sulfides) are frequently used.
- Not to install on top of the musical instruments, TV, computer etc. valuable appliance.
- Not to install a fire alarming device near the air outlet of the unit (during operation, the fire alarm device might be erroneously triggered by the warm air from the unit);

■ Make sure of enough space for installation and maintenance.

- To take into consideration the operational convenience and safety in installation, it is recommended to ensure enough space between the unit and the walls.

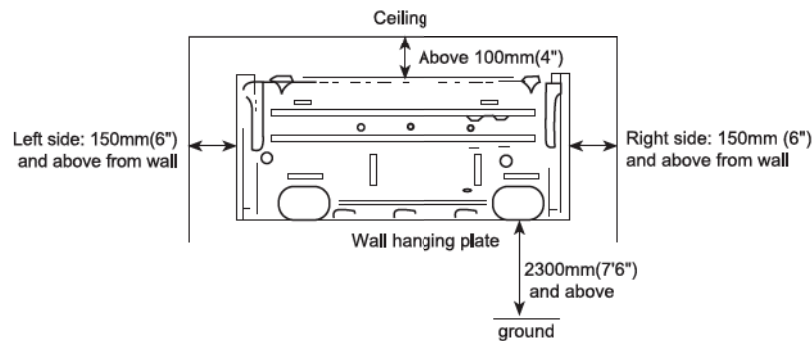

Attention: If there are some additional function devices to install on the air conditioner, Be sure add to the installation space for the function devices.

■ Height limits of indoor and outdoor units.

- Either the indoor unit or the outdoor unit can be higher, but the height difference must comply the stated requirements.
- Try to reduce the bending of the piping line as much as possible so as to avoid possible negative impacts upon the performances of the units.

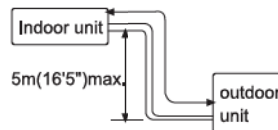

【Selection of installation positions for outdoor unit】

- To install the outdoor unit at the places which can stand the load of the machine weight and will not cause big vibrations and noises;
- To install the unit at the places not to be exposed to rain or direct sunshine, and the places with good ventilation;
- The noises generated from the unit will not affect the neighboring places;
- Do not install the unit on non-metal frame;
- Not to install the unit at the places where there might occur the generation, inflow, stay or leakage of inflammable gases;
- Pay attention to the drainage of the condensed water from the base plate during operations;
- To avoid the air outlet being directly against the wind.

Detailed space requirements around the outdoor unit

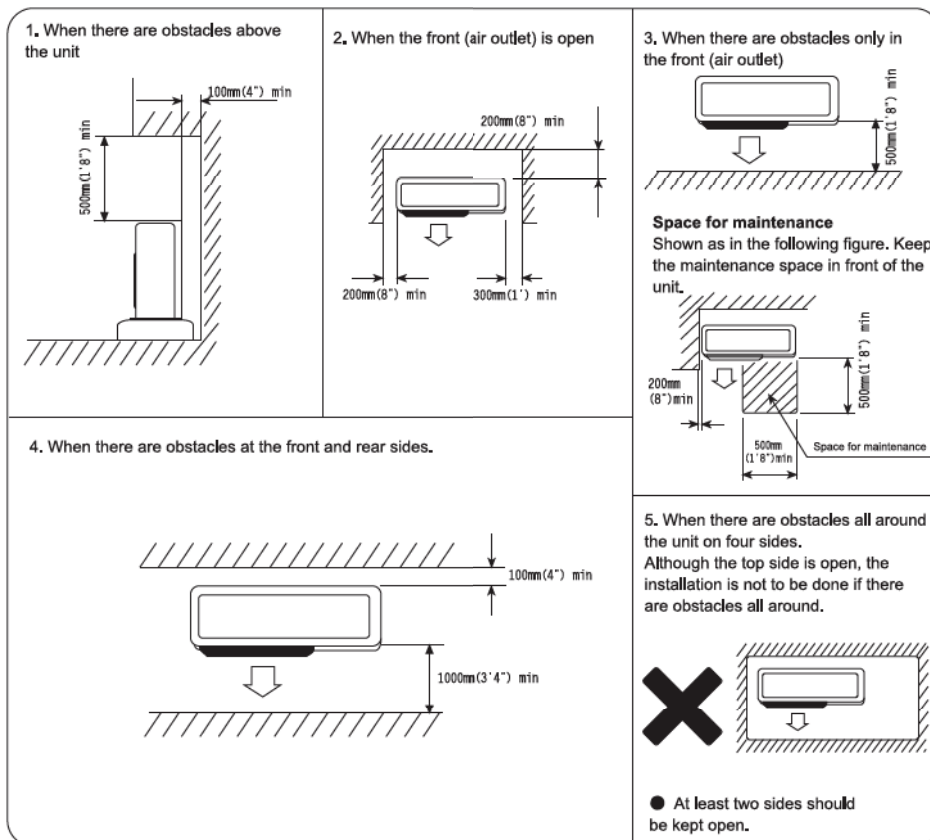

【Installation fixture of indoor unit】

Pipelines can be connected in the directions of ①、 ②、 ③、 ④、 and ⑤ as indicated in Fig.1. When the pipelines are connected to the directions of ③、 ④ and ⑤, a groove for the pipes has to be opened at the proper place on the base stand.

Fig.1

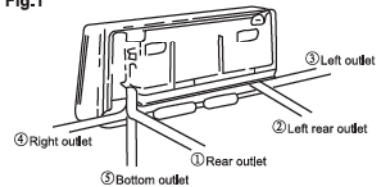

1.Installation of wall-mounting plate

Fix the wall-mounting plate firmly on the wall with screws. Make sure of the leveling of the plate. Slanted wall-mounting plate might jeopardize the smooth discharge of the condensed water.

2.Drill holes on the wall

Drill holes at places slightly below the wall-mounting plate, with hole diameter of 65mm(2-3/5") and the outer edge of the hole 5-10mm(1/5-2/5") lower (Fig.2) so that the condensed water can smoothly flow out. Cut the wall penetrating pipe to proper length according to the thickness of the wall (3-5mm(1/10-1/5") longer than the wall thickness) and insert the pipe as indicated in Fig.2.

Fig.2

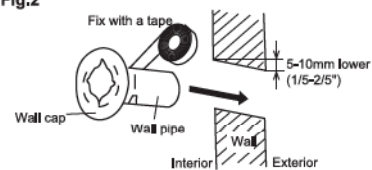

3.Installation of drain pipe

Install the pipelines of the indoor unit in accordance with the direction of the wall holes. Wrap tightly the drain pipe and the pipelines with tape. Make sure that the drain pipe is underneath the pipelines. (Fig.3) (When the drain pipe passes the room interior, some condensed water might occur to its surfaces if the humidity is very high).

Fig.3

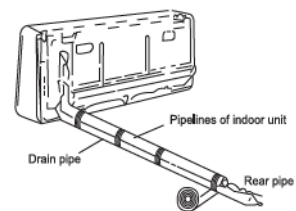

4.Installation of indoor unit

Pass the connection wires, connecting pipelines and drain pipe through the wall hole. Hang the indoor unit on the hooks at the top of the wall-mounting plate so that the hooks at the bottom of the indoor unit match the hooks of the wall-mounting plate. (Fig.4)

Fig.4

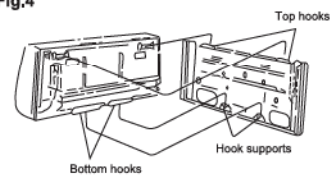

Inspections:

- Check if the hooks at the top and bottom are firmly fixed.
- Check if the position of the master unit is properly leveled.
- The drain pipe should not curve upward (Fig.5).
- The drain pipe should be at the lower part of the wall pipes (Fig. 5).

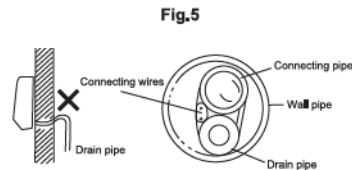

【Installation fixture of outdoor unit】

- Try to ship the product to the installation location in its original package;
- As the gravity center of the unit is not at the installation center, special caution should be taken when using hoisting cables to lift it up;
- During shipping, the outdoor unit must not be slanted to over 45 degrees (Do not store the unit in a horizontal way).
- Use expansion bolts to fix the mounting supports on the wall;
- Use bolts and nuts to fix the outdoor unit firmly on the supports and keep on the same level;
- If the unit is installed on the wall or at the rooftop, the supports have to be firmly fixed so as to resist earthquake or strong wind.

Dimensions for parallel units installations

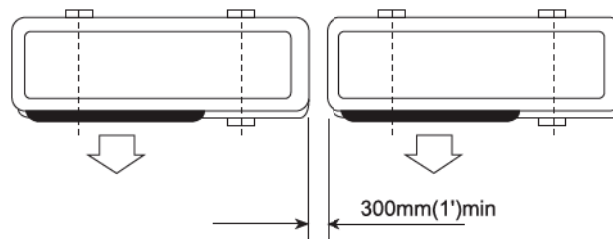

【Ordinary pipelines connection & Air purging】

- The following ordinary pipelines connection and air purging procedures are just suitable for non-quick coupler model.

■ Ordinary pipelines connection

No dust, foreign articles, air or moisture should be allowed to enter the air conditioning system. Careful attention should be paid when pipeline connection for outdoor unit is made. Try to avoid repeated curves as much as possible, otherwise hardening or cracks might be caused to the copper pipes. Suitable wrenches should be used when the pipeline connection is done so as to ensure appropriate torque (refer to following torque Table 1). Excessive torque might damage the joints while too little torque might lead to leakage.

Table 1 Torque based upon the wrench to be used

Outer diameter of copper pipe	Tightening torque	Strengthened tightening torque
∅ 6.35(1/4")	160kgf.cm(63kgf.inch)	200kgf.cm(79kgf.inch)
∅ 9.52(3/8")	300kgf.cm(118kgf.inch)	350kgf.cm(138kgf.inch)
∅ 12.7(1/2")	500kgf.cm(197kgf.inch)	550kgf.cm(216kgf.inch)
∅ 15.88(5/8")	750kgf.cm(295kgf.inch)	800kgf.cm(315kgf.inch)
∅ 19.05(3/4")	1200kgf.cm(472kgf.inch)	1400kgf.cm(551kgf.inch)

■ Air purging with vacuum pump

1. Check that pipelines connection have been properly connected, remove the charging port cap, and connect the manifold gauge and the vacuum pump to the charging valve by service hoses as shown Fig.6.

2. Open the valve of the low pressure side of manifold gauge, then, run the vacuum pump. Vacuum the indoor unit and the connecting pipes until the pressure in them lowers to below 1.5mmHG (The operation time for vacuuming is about 10 minutes). When the desired vacuum is reached, close the valve of the low pressure of the manifold and stop the vacuum pump.

3. Disconnect the service hoses and fit the cap to the charging valve.

4. Remove the blank caps, and fully open the spindles of the 2-way and 3-ways valves with a service valve wrench.

5. Tighten the blank caps of the 2-way and 3-ways valves, applying the above torque Table 1.

■ Adding refrigerant

Refrigerant must be added if the piping measures more than 5 metres (16'5") in length. This operation can only be performed by a professional technician, for the additional amount, see the table 2 below.

Table 2

Additional refrigerant amount	
Liquid pipe diameter ∅6.35(1/4")	Liquid pipe diameter: ∅9.52(3/8")
(piping length-5)m x 30g or (piping length-16)ft x 0.3oz	(piping length-5)m x 65g or (piping length-16)ft x 0.7oz

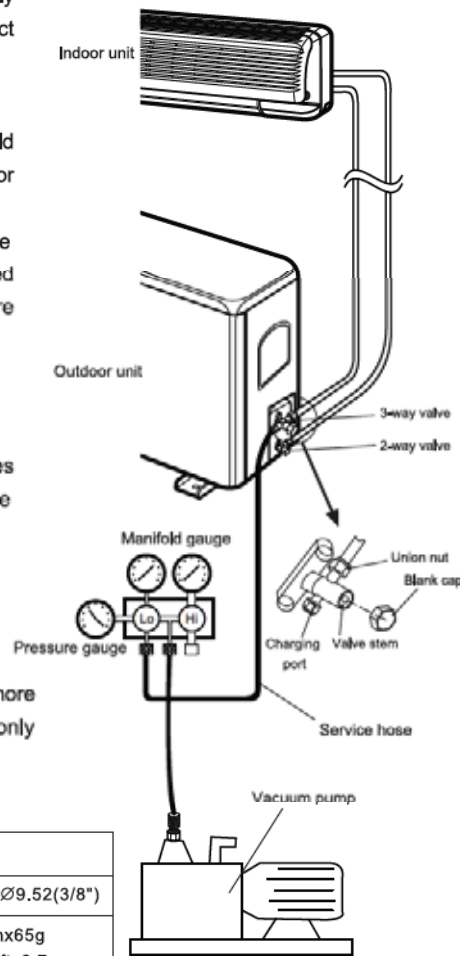

Fig.6

■ Gas leakage inspection

After the pipeline connection is done, use a leakage inspection device or soap suds to carefully check if there is any leakage at the joints. This is an important step to ensure the quality of installation. Once a leakage is detected, proper treatment should be taken immediately.

【Pipelines connection for Split type quick coupler model】

● If you purchase the machine for split type quick coupler model, please adopt the following pipelines connection procedures:

1. Remove the dust caps from the indoor and outdoor units, and the connecting pipe.

2. Align the joint counter of connecting pipe with the proper indoor and outdoor joint conic surfaces, tighten the connecting nut manually. Then, make it secure with a wrench as shown Fig.7, applying to above torque Table 1.

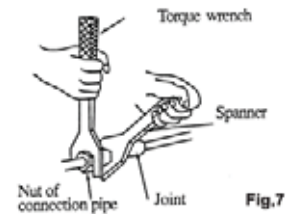

Fig.7

3. Remove the two valve core caps from the outdoor unit.

4. Turn on the high and low pressure valve cores with a socket wrench, then tighten the two valve core caps of the outdoor unit (Fig.8).

5. Finally, wrap the hot insulating cotton around the joints of indoor and outdoor units.

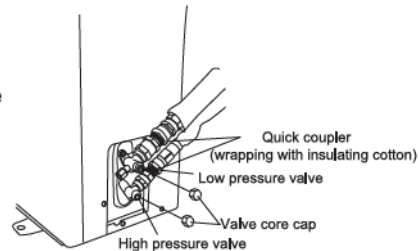

Fig.8

● Notes on installation of quick coupler:

1. Connecting pipe bending minimum radius parameters (Table 3)

2. Quick coupler assembly and disassembly limit: the assembly and disassembly times are inadvisably more than 7.

Table 3 Minimum bending radius

Normal diameter(mm)	Minimum bending radius(mm)	cooling capacity
DN8(5/16")	80(3")	2100~2300W (7000~8000BTU)
DN10-12 (1/2")	100(4")	2500~5100W (9000~18000BTU)
DN14-16 (5/8")	150(6")	6100~7000W (22000~24000BTU)

【Pipelines connection for Whole-Unit type quick coupler model】

● If you purchase the machine for Whole-Unit type quick coupler model, please adopt the following pipelines connection procedures:

STEP 1

● Remove two screws on the maintenance plate with a screwdriver and take off the plate, then remove the dust caps on both indoor male coupler and outdoor female coupler, See Fig.9.

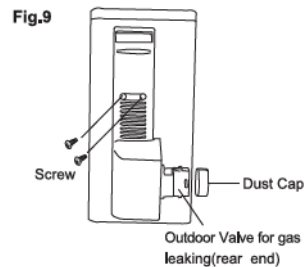

STEP 2

● Press the projecting section of outdoor female coupler backward with a little force by the thumb to make inner hooks open, and then you can easily take out the outdoor valve for gas leaking by the other hand, See Fig.10.

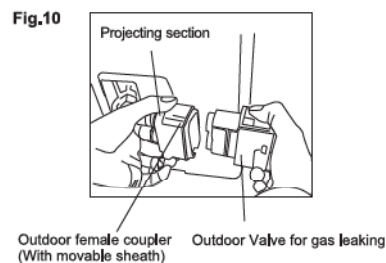

STEP 3

● In the same way, press the projecting section backward, then connect the indoor male coupler to the outdoor female coupler, See Fig.11.

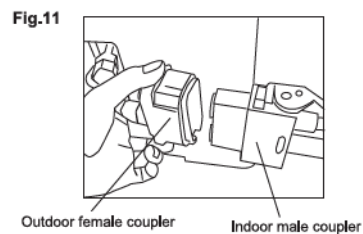

STEP 4

● Close the key lever of indoor male coupler to the horizontal position, then indoor and outdoor refrigerant will be circulating, and now you can obviously hear the sound of inner air flowing, See Fig.12.

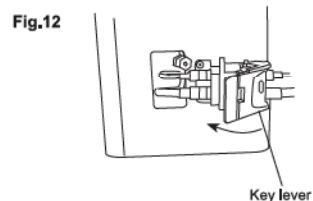

STEP 5

● Connect the outdoor quick cable coupler with indoor quick cable coupler, See Fig.13.

STEP 6

● Finally, Re-install the maintenance plate back into its place, See Fig.14.

As for the outdoor valve for gas leaking and the dust caps, you can preserve them for future possible use on the removal of your air conditioner.

Fig.13

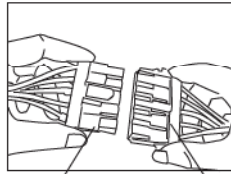

Outdoor quick cable coupler Indoor quick cable coupler

【Connection of power cable】

- 1.Remove the drawer of the outdoor unit.
- 2.**Non-quick coupler**:connect the indoor power and control wires with the matched outdoor wires in accordance with the electric schematic diagram and make sure that the connection is firmly done(Fig.15.)

Quick coupler:directly connect quick cable couplers with indoor and outdoor quick cable couplers after disassembly of the outdoor unit connecting box cover(Fig.16.)

- 3.Use a press plate to fix the wires firmly,and re-install the drawer.
- 4.Optional steps:In some cooling and heating models,you should connect the indoor wire connector with outdoor probe wire connector for defrosting,see Fig.17.

Fig.14

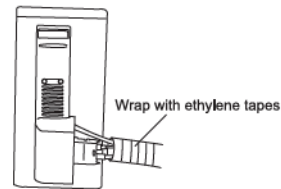

Fig.15

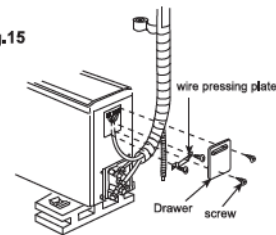

Fig.16

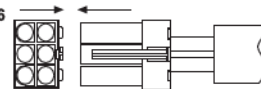
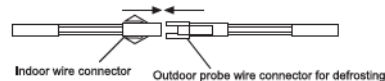

Fig.17



Note:Do not connect the wires in a wrong way,otherwise electric malfunctions will be caused and even damages to the units will occur.The appliance shall be installed in accordance with national wiring regulation.If the supply cord is damaged,it must be replaced by the manufacturer or its service agent or a similarly qualified person in order to avoid a hazard.The plug shall be accessible after installing the appliance.If the model have not plug that a switch which have a contact separation of at least 3 mm in all poles shall be added in fixed wiring.

【Finishing touches】

- wrap the pipelines tightly with ethylene tapes.
- Fix the wrapped pipelines on the exterior wall with clamps.
- Fill in the gaps left over by the pipeline hole and wall hole to prevent rain-water from entering.

【Test running】

- Connect to the power source,check if the function selection keys on the remote controller are working properly.
- Check if the room temperature adjustments and timer settings are working properly.
- Check if the drain is smooth.
- Check if there is any abnormal noise or vibration during operation.
- Check if there is leakage of refrigerant.

【Is the unit installed correctly?】

■ Suitable Installation Position

- Isn't there anything which prevents ventilation or obstructs operation in front of the indoor unit ?
Do not install the unit following place .
 - Inflammable gases may leak .
 - Oil splashes a lot .
 - In case where the unit is used in such places as poisonous or sultry gases are generated or seaside district exposed to sea breezes corrosion may cause malfunction . Consult with your distributor .
 - Air conditioner body and remote controller must be 1 m(39-3/4") or more away from a TV or a radio.
- Drain the dehumidified water from the indoor unit to a place which drains well .

■ Pay attention to operation noise

- When installing the unit , choose a place which can stand the weight of the unit well and does not increase the operation noise or vibration . Especially where there is a possibility that vibration be transmitted to the house , fix the unit by inserting attached vibration -proof pads between the unit and fittings .
- Choose the place where hot air and operation noise from the outlet of the outdoor unit do not annoy the neighborhood .
- Things left near the outlet and inlet of the outdoor unit cause malfunction or increased operation noise . Do not leave obstacles near the outlet and inlet .
- If irregular sound is heard during operation , consult with your distributor .

■ Inspection and Maintenance

- According to the service conditions and operating environment , the inside of the air conditioner will become dirty after several seasons (3 to 5years) of service , resulting in decreased operating performance .Inspection and maintenance are recommended in addition to usual cleaning (The air conditioner can be used for a longer period and without anxiety .)
- As to inspection and maintenance , consult your dealer or any one of business offices of dealing companies .(Service charge is required in this case .)
- We recommend to perform inspection and maintenance during an off seasons.

【Self Diagnosis Functions】

Our company provides the thoughtful services for customer,air conditioners had been installed self diagnosis system to display the information for the units.

<i>Self-check information</i>	<i>Self-check code of luminotron/ (Self-check code of running lamp)</i>	<i>Digital self-check code/ (Polychrome screen self-check code)</i>
Hint to defrosting	Flicker 1 time/1s	Indicates "dF"or defrosting indicator displays
Hint to defense against cold wind	Flicker 1 time/3s	Fan motor picture not running
Failure of room temperature sensor	Flicker 2 times/4s (Flicker 2 times/8s)	E2/(L2)
Failure of coiled pipe sensor	Flicker 3 times/5s (Flicker 1 time/8s)	E3/(L1)
Abnormality of outdoor unit	Flicker 4 times/6s (luminating)	E4/(E5)
Without feedback of internal fan motor	Flicker 5 times/7s (Flicker 6 times/8s)	E5/(L6)
Zero crossing signal without current	Flicker 6 times/8s	E6
External feedback failure	Flicker 7 times/9s	E7
Overheat protection	Flicker 8 times/10s	E8
Water pump failure	Flicker 9 times/11s	E9

Note:Above self check information is commonly applicable in our most air conditioners,but some are special,you can refer to the User's Manual for information or contact the dealer or authorized maintenance people for help.











【Quick connector installation instruction】

This sheet only guides the requirements of the installation for stainless quick connector pipe. Other installation requirements please refer to the installation guide along with the unit.

- To expand the connecting pipe, please hold one side then expand it following the right direction.
- Please insure the angles have a radian at some extent while installing the stainless soft pipe. Angles need to be around, not bended, (to the quick connecting spot and drilled point of wall).
- Please fix the stainless soft pipe while installing because the connecting pipes are soft, so that prevent them from getting bended or stretched.
- The minimum bending radius are as follows:

<i>Stainless soft pipe</i>	<i>Model</i>	<i>Minimum bending radius(mm)</i>
Φ Eight	Twenty-one, Twenty-five	Eighty(mm)
Φ Ten	Thirty-five	One hundred(mm)
Φ Thirteen	fifty-one	One hundred and fifteen(mm)

【Installation Guide】

<p>To keep the allowed bending radius, please make the packed soft pipes vertical for expanding.</p>			<p>Please do not expand only one side of the packed soft pipes.</p>
<p>Please make use of semicircle pulley to keep the allowed bending radius.</p>			<p>Extremely bending could damage the pipes.</p>
<p>Please use twisting wheel to avoid improper bending.</p>			<p>Over length soft pipes will lead to irregular bending.</p>
<p>Please use rigid elbow to keep the bending radius while soft pipes operating.</p>			<p>Undersize bending will damage the soft pipe.</p>
<p>Please Keep the minimum bending radius while installing.</p>			<p>Short soft pipes will have them bending undersize, it's not allowed.</p>