

PACKAGED TERMINAL AIR CONDITIONER

WITH
HEAT PUMP/HEAT STRIP

• QUICK START GUIDE •

The design and specifications are subject to change without prior notice for product improvement. Consult with the sales agency or manufacturer for details.

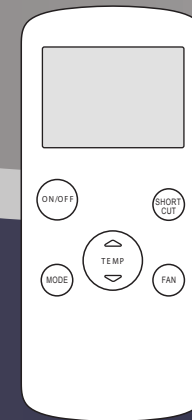

CONTENTS

Remote control Specifications.....	2
Function buttons	3
Handling the remote control	4
Remote LCD screen indicators	5
How to use the basic functions.....	6
How to use the advanced functions	7

Remote Control Specifications

Rated Voltage	3.0V(Dry batteries R03/LR03×2)
Signal Receiving Range	8m
Environment	-5°C~60°C(23°F~140°F)

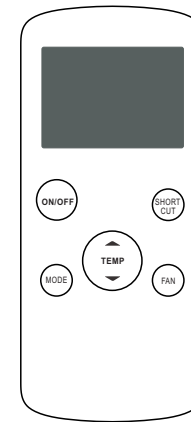

RG57J(B)/BG(C)E

Function Buttons

Before you begin using your new air conditioner, make sure to familiarize yourself with its remote control. The following is a brief introduction to the remote control itself. For instructions on how to operate your air conditioner, refer to the **How to Use Basic Functions** section of this manual.

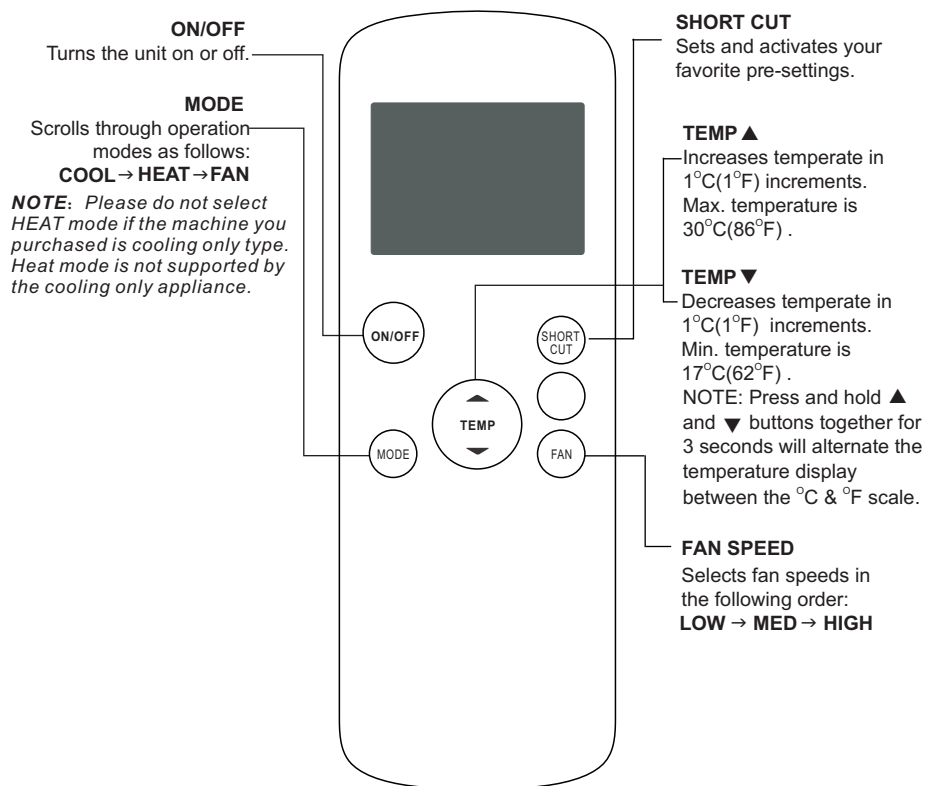

Handling The Remote Control

NOT SURE WHAT A FUNCTION DOES?

Refer to the How to Use Basic Functions and How to Use Advanced Functions sections of this manual for a detailed description of how to use your air conditioner.

SPECIAL NOTE

- Button designs on your unit may differ slightly from the example shown.
- If the indoor unit does not have a particular function, pressing that function's button on the remote control will have no effect.
- When there are wide differences between "Remote controller Illustration" and "USER'S MANUAL" on function description, the description of "USER'S MANUAL" shall prevail.

Inserting and Replacing Batteries

Your air conditioning unit comes with two AAA batteries. Put the batteries in the remote control before use.

1. Slide the back cover from the remote Control downward, exposing the battery compartment.
2. Insert the batteries, paying attention to match up the (+) and (-) ends of the batteries with the symbols inside the battery compartment.
3. Slide the battery cover back into place.

! BATTERY NOTES

For optimum product performance:

- Do not mix old and new batteries, or batteries of different types.
- Do not leave batteries in the remote control if you don't plan on using the device for more than 2 months.



BATTERY DISPOSAL

Do not dispose of batteries as unsorted municipal waste. Refer to local laws for proper disposal of batteries.

TIPS FOR USING REMOTE CONTROL

- The remote control must be used within 8 meters of the unit.
- The unit will beep when remote signal is received.
- Curtains, other materials and direct sunlight can interfere with the infrared signal receiver.
- Remove batteries if the remote will not be used more than 2 months.

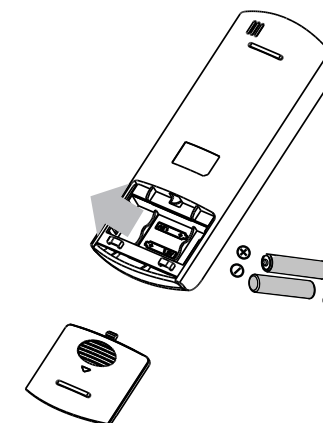
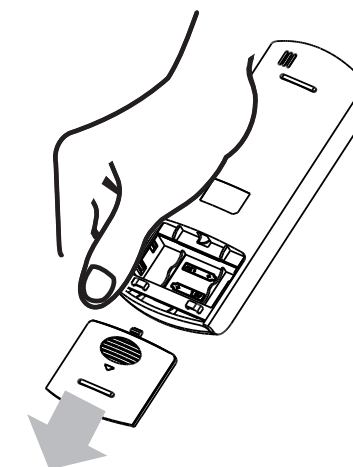

Remote LCD Screen Indicators

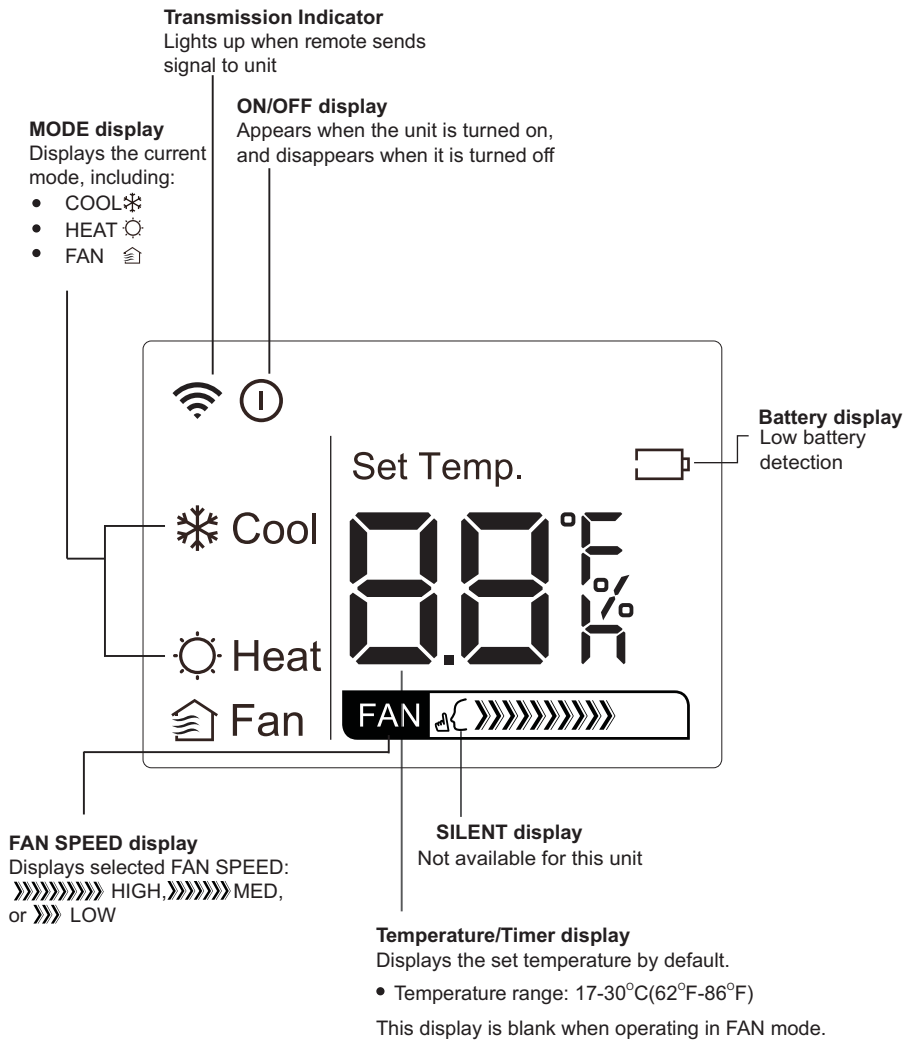

How To Use The Basic Functions

SETTING TEMPERATURE

The operating temperature range for units is 17-30°C. You can increase or decrease the set temperature in 1°C increments.

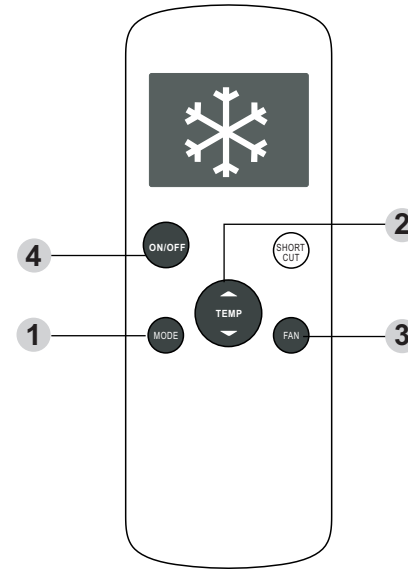

COOL operation

1. Press the **MODE** button to select **COOL** mode.
2. Set your desired temperature using the **Temp ▲** or **Temp ▼** button.
3. Press the **FAN** button to select the fan speed: LOW, MED, or HIGH.
4. Press the **ON/OFF** button to start the unit.

HEAT operation

1. Press the **MODE** button to select **HEAT** mode.
2. Set your desired temperature using the **Temp ▲** or **Temp ▼** button.
3. Press the **FAN** button to select the fan speed: LOW, MED, or HIGH.
4. Press the **ON/OFF** button to start the unit.

NOTE: As outdoor temperature drops, the performance of your unit's HEAT function may be affected. In such instances, we recommend using this air conditioner in conjunction with other heating appliance.

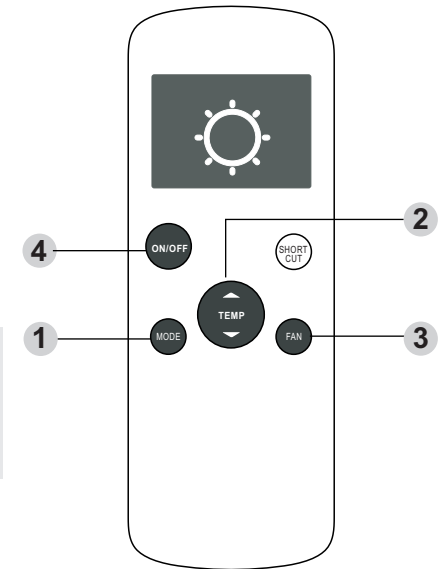

How To Use The Basic Functions

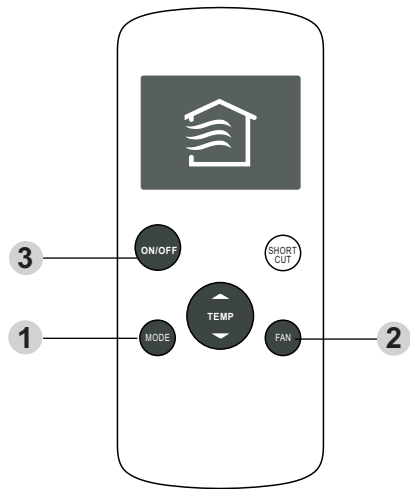

FAN operation

1. Press the **MODE** button to select FAN mode.
2. Press **FAN** button to select the fan speed: HIGH, MED or LOW.
3. Press the **ON/OFF** button to start the unit.

NOTE: You can't set temperature in FAN mode. As a result, your remote control's LCD screen will not display temperature.

How To Use The Advanced Functions

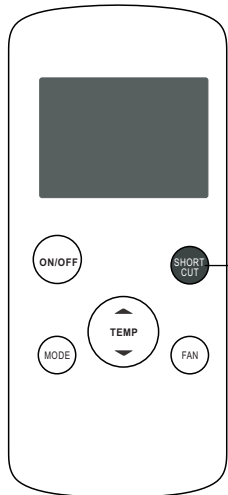

SHORTCUT function

- Used to restore the current settings or resume previous settings.
- Push this button when remote control is on, the system will automatically revert back to the previous settings including operating mode, setting temperature, fan speed level and sleep feature (if activated).
- If pushing more than 2 seconds, the system will automatically restore the current operation settings including operating mode, setting temperature, fan speed level and sleep feature (if activated).

NOTE:

- Buttons design is based on typical model and might be slightly different from the actual one you purchased, the actual shape shall prevail.
- All the functions described are accomplished by the unit, if the unit has no this feature, there is no corresponding operation happened when press the relative button on the remote control.
- When there are wide differences between "Remote control Illustration" and "USER'S MANUAL" on function description, the description on "USER'S MANUAL" shall prevail.
- The device could comply with the local national regulations. In Canada, it should comply with CAN ICES-3(B)/NMB-3(B). In USA, this device complies with part 15 of the FCC Rules. Operation is subject to the following two conditions: (1) This device may not cause harmful interference, and (2) this device must accept any interference received, including interference that may cause undesired operation.
- This equipment has been tested and found to comply with the limits for a Class B digital device, pursuant to part 15 of the FCC Rules. These limits are designed to provide reasonable protection against harmful interference in a residential installation. This equipment generates, uses and can radiate radio frequency energy and, if not installed and used in accordance with the instructions, may cause harmful interference to radio communications. However, there is no guarantee that interference will not occur in a particular installation. If this equipment does cause harmful interference to radio or television reception, which can be determined by turning the equipment off and on, the user is encouraged to try to correct the interference by one or more of the following measures:
 - Reorient or relocate the receiving antenna.
 - Increase the separation between the equipment and receiver.
 - Connect the equipment into an outlet on a circuit different from that to which the receiver is connected.
 - Consult the dealer or an experienced radio/TV technician for help.Changes or modifications not approved by the party responsible for compliance could void user's authority to operate the equipment.