

MULTI-ZONE SPLIT AIR CONDITIONER WITH HEAT PUMP

Quick- Start Guide

The design and specifications are subject to change without prior notice for product improvement. Consult with the sales agency or manufacturer for details.

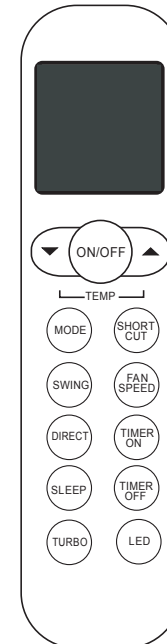

IMPORTANT NOTE:

Read this manual carefully before installing or operating your new air conditioning unit. Be sure to save this manual for future reference.

CONTENTS

Handling the remote control	2
Remote control specifications.....	3
Function buttons	4
Indicators on LCD	7
How to use the buttons	8
Auto/Cool operation.....	8
Dry/Fan operation.....	9
Heat operation	10
Setting the timer function	11

Handling the remote control

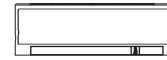

Location of the remote control

- Use the remote control within a distance of 8 meters from the appliance, pointing it toward the receiver. Reception is confirmed by a beep.

CAUTIONS

- The air conditioner will not operate if curtains, doors, or other materials block the signals from the remote control to the indoor unit. Prevent any liquid from falling into the remote control. Do not expose the remote control to direct sunlight or heat.
- If the infrared signal receiver on the indoor unit is exposed to direct sunlight, the air conditioner may not function properly. Use curtains to prevent sunlight from falling on the receiver.
- If other electrical appliances react to the remote control, either move those appliances or consult your local dealer.

Replacing batteries

The remote control is powered by two dry batteries (R03/LR03X2) housed in the rear part and protected by a cover.

- (1) Remove the cover by pressing it and sliding it off.
- (2) Remove the old batteries and insert the new batteries, placing the (+) and (-) ends correctly.
- (3) Reattach the cover by sliding it back into position.

NOTE: When the batteries are removed, the remote control erases all programming. After new batteries are inserted, the remote control must be reprogrammed.

CAUTIONS

- Do not mix old and new batteries or batteries of different types.
- Do not leave the batteries in the remote control if they will not be used for 2 or 3 months.
- Do not dispose batteries as unsorted municipal waste. Collection of such waste separately for special treatment is necessary.

Remote controller specifications

Rated Voltage	3.0V (Dry batteries R03/LR03X2)
Signal Receiving Range	26.2 ft (8 m)
Environment	23°F - 140°F (-5°C ... 60°C)

Performance feature

1. Operating Mode: AUTO, COOL, DRY, HEAT (Except in cooling-only model without), and FAN
2. Timer setting function in 24 hours
3. Indoor setting temperature range: 62°F - 86°F (17°C - 30°C)
4. Full function of LCD (Liquid Crystal Display).

NOTE:

- Button design might be slightly different from the actual one you purchased, depending on individual models.
- All the functions described are accomplished by the indoor unit. If the indoor unit does not have this feature, no corresponding operation will occur when the relative button is pressed on the remote control.

Function buttons

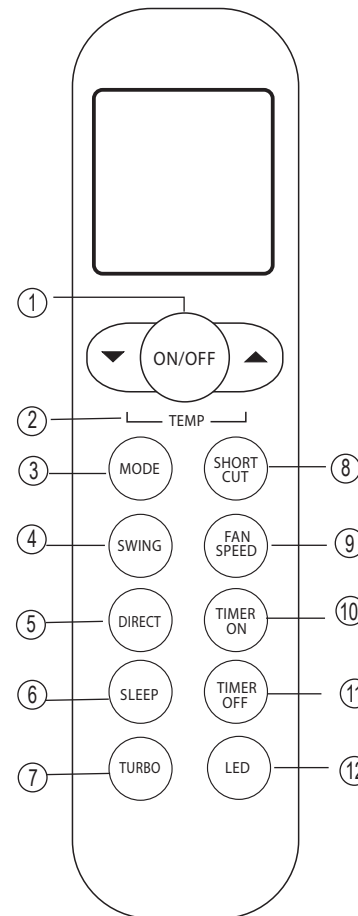

- ① **ON/OFF button**
Turns the unit on or off.

- ② **TEMP ▲**
Increases temperature in 2°F (1°C) increments. Max. temperature is 86°F (30°C)

- TEMP ▼**
Decreases temperature in 2°F (1°C) increments. Min. temperature is 62°F (17°C).

- ③ **MODE button**
Scrolls through operation modes as follows:
AUTO → COOL → DRY → HEAT
→ FAN

NOTE: Please do not select HEAT mode if the machine you purchased is a cooling-only model. Heat mode is not supported by the cooling-only appliance.

- ④ **SWING button**
Used to stop or start horizontal louver movement.

- ⑤ **DIRECT button**
Used to adjust the louver movement and set the desired up/down air flow direction. Each time you press the button, it will adjust the louver by 6°.

- ⑥ **SLEEP button**
- Activate/Disable sleep function. it can maintain the most comfortable temperature and save energy.
 - For details, see "Sleep operation" in "USER'S MANUAL"

NOTE: While the unit is running under SLEEP mode, it will be cancelled if the MODE, FAN, or ON/OFF button is pressed.

Function buttons

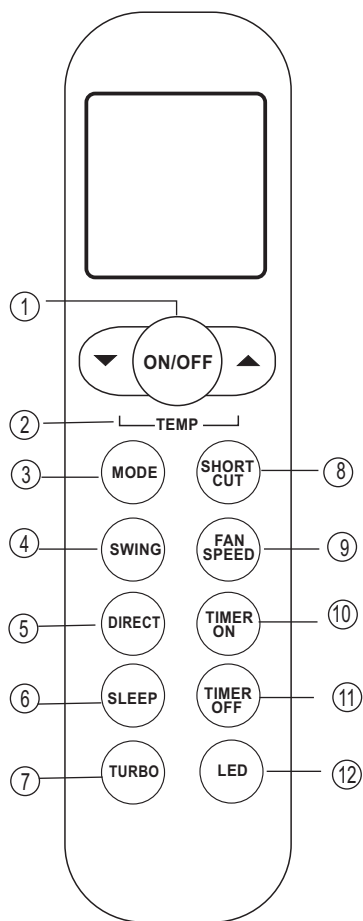

- 7 TURBO button:**
Activate/Disable TURBO function. Turbo function enables the unit to reach the preset temperature in the shortest possible time. If the indoor unit does not have this feature, no corresponding operation will occur when the button is pressed.
- 8 SHORTCUT button**
- Sets and activates your favorite pre-settings.
 - The first time the unit is connected to the power, when you press this button, the fan speed will be set to AUTO mode, 75.2°F (24°C).
 - When the remote control is on, pressing this button will cause the system to automatically revert back to the previous settings, including operating mode, setting temperature, fan speed level, and sleep feature (if activated).
 - If this button is held for more than 2 seconds, the system will automatically restore the current operation settings, including operating mode, setting temperature, fan speed level, and sleep feature (if activated).
- 9 FAN SPEED button**
Selects fan speeds in the following order:
AUTO → LOW → MED → HIGH
- 10 TIMER ON button**
Sets timer to turn unit on. Each press will increase the auto-timed setting in 30-minute increments. When the setting time displays 10H, each press will increase the auto-timed setting in 60-minute increments. To cancel the auto-timed program, simply adjust the auto-on time to 0.0.

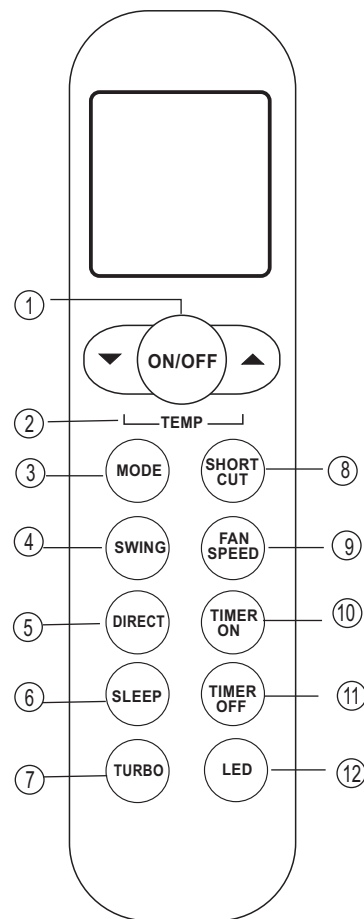

- 11 TIMER OFF Button**
Sets timer to turn unit off. Each press will increase the auto-timed setting in 30-minute increments. When the setting time displays 10H, each press will increase the auto-timed setting in 60-minute increments. To cancel the auto-timed program, simply adjust the auto-off time to 0.0.
- 12 LED Button**
Turns indoor unit's LED display on and off.

Indicators on LCD

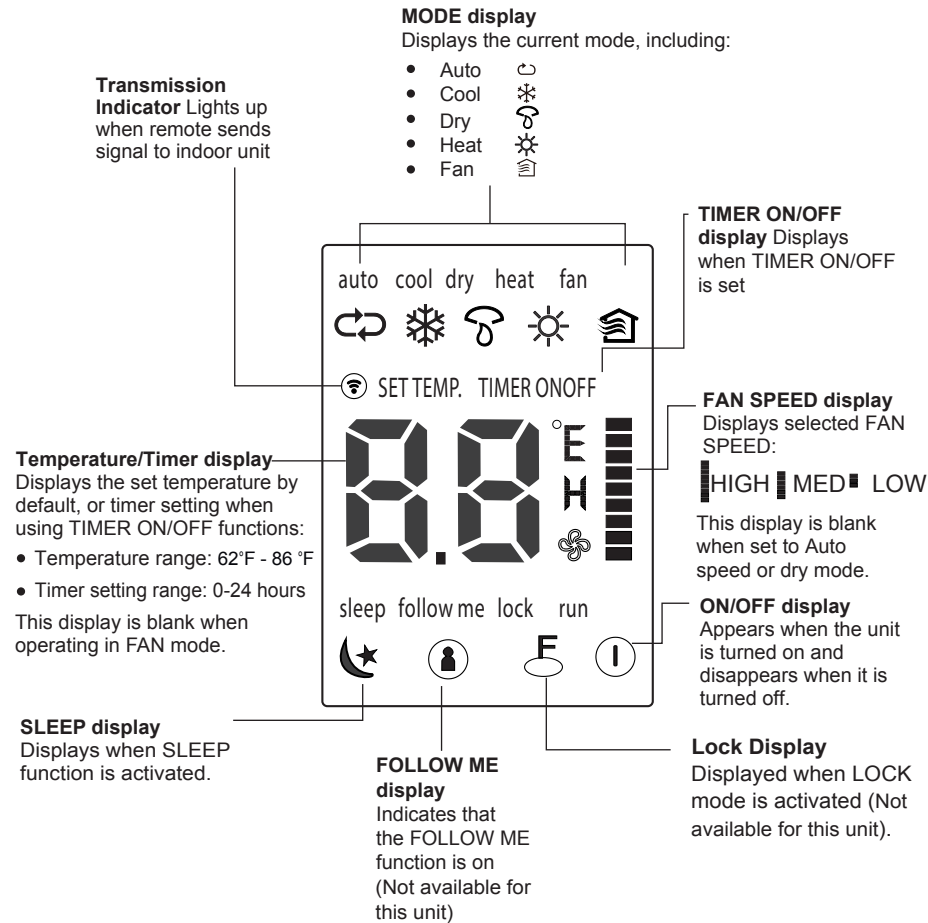

Note:

All indicators shown in the figure are for the purpose of clear presentation. During the actual operation, only the relative functional signs are shown on the display window.

How to use the buttons

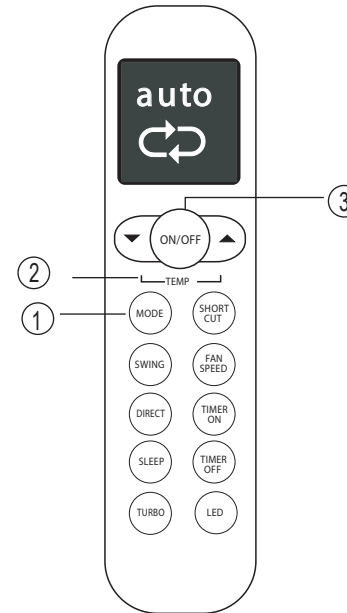

AUTO operation

SETTING TEMPERATURE

The operating temperature range for units is 62-86 °F (17-30 °C). You can increase or decrease the set temperature in 2°F (1°C) increments.

In **AUTO** mode, the unit will automatically select the COOL, FAN, HEAT, or DRY mode based on the set temperature.

1. Press the **MODE** button to select Auto mode.
2. Set your desired temperature using the **Temp ∇** or **Temp ∆** button.
3. Press the **ON/OFF** button to start the unit.

NOTE: FAN SPEED can't be set in AUTO mode.

COOL operation

1. Press the **MODE** button to select **COOL** mode.
2. Set your desired temperature using the **Temp ∇** or **Temp ∆** button.
3. Press the **FAN** button to select the fan speed: AUTO, LOW, MED, or HIGH.
4. Press the **ON/OFF** button to start the unit.

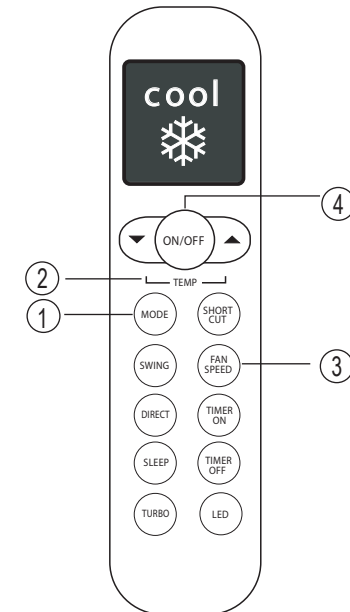

How to use the buttons

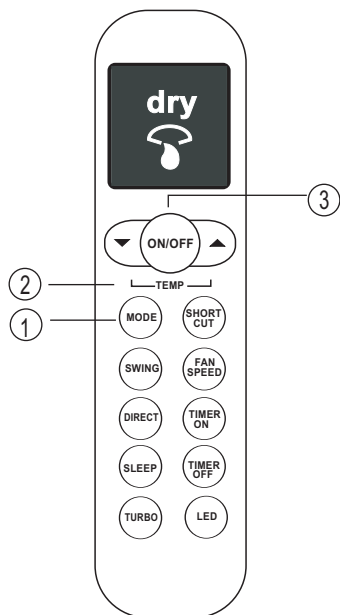

DRY operation (dehumidifying)

1. Press the **MODE** button to select **DRY** mode.
2. Set your desired temperature using the **Temp** ∇ or **Temp** \blacktriangle button.
3. Press the **ON/OFF** button to start the unit.

NOTE: **FAN SPEED** can't be changed in **DRY** mode.

FAN operation

1. Press the **MODE** button to select **FAN** mode.
2. Press the **FAN** button to select the fan speed: **AUTO**, **LOW**, **MED**, or **HIGH**.
3. Press the **ON/OFF** button to start the unit.

NOTE: Temperature can't be set in **FAN** mode. As a result, your remote control's LCD screen will not display temperature.

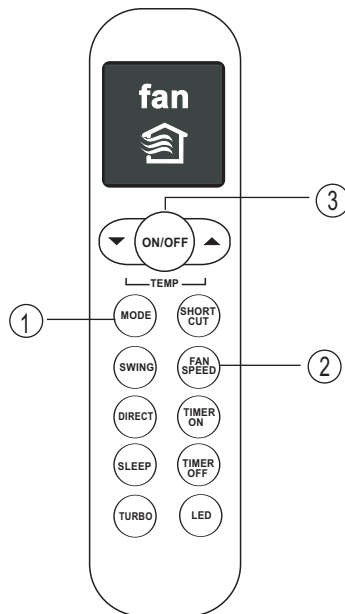

How to use the buttons

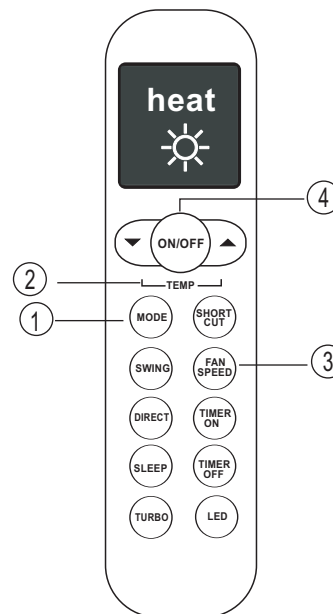

HEAT operation

1. Press the **MODE** button to select **HEAT** mode.
2. Set your desired temperature using the **Temp** ∇ or **Temp** \blacktriangle button.
3. Press the **FAN** button to select the fan speed: **AUTO**, **LOW**, **MED**, or **HIGH**.
4. Press the **ON/OFF** button to start the unit.

NOTE: As outdoor temperature drops, the performance of your unit's **HEAT** function may be affected. In such instances, we recommend using this air conditioner in conjunction with other heating appliances.

Setting the TIMER function

Your air conditioning unit has two timer-related functions:

- **TIMER ON**- sets the amount of time after which the unit will automatically turn on.
- **TIMER OFF**- sets the amount of time after which the unit will automatically turn off.

TIMER ON function

The **TIMER ON** function allows you to set a period of time after which the unit will automatically turn on, such as when you come home from work.

1. Press the **TIMER ON** button. By default, the last time period that you set and an "h" (indicating ho urs) will appear on the display.
Note: This number indicates the amount of time after the current time that you want the unit to turn on. For example, if you set **TIMER ON** for 2 hours, "2.0H" will appear on the screen, and the unit will turn on after 2 hours.
2. Press the **TIMER ON** button repeatedly to set the time that you want the unit to turn on.
3. After 2 seconds, the **TIMER ON** function will be activated. The digital display on your remote control will then return to the temperature display.

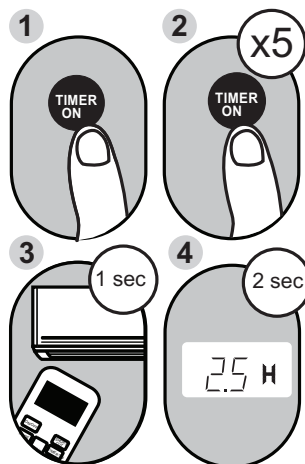

Example: Setting unit to turn on after 2.5 hours.

TIMER OFF function

The **TIMER OFF** function allows you to set a period of time after which the unit will automatically turn off, such as when you wake up.

1. Press the **TIMER OFF** button. By default, the last time period that you set and an "h" (indicating ho urs) will appear on the display.
Note: This number indicates the amount of time after the current time that you want the unit to turn off. For example, if you set **TIMER OFF** for 2 hours, "2.0H" will appear on the screen, and the unit will turn off after 2 hours.
2. Press the **TIMER OFF** button repeatedly to set the time that you want the unit to turn off.
3. After 2 seconds, the **TIMER OFF** function will be activated. The digital display on your remote control will then return to the temperature display.

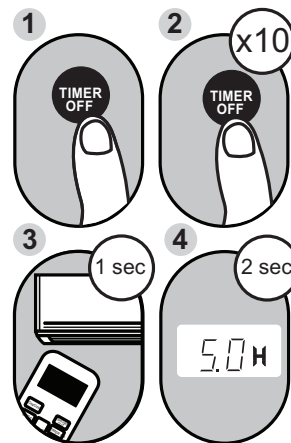

Example: Setting unit to turn off after 5 hours.

NOTE: When setting the **TIMER ON** or **TIMER OFF** functions, up to 10 hours, the time will increase in 30-minute increments with each press. After 10 hours and up to 24, it will increase in 1-hour increments. The timer will revert to zero after 24 hours. You can turn off either function by setting its timer to "0.0h".

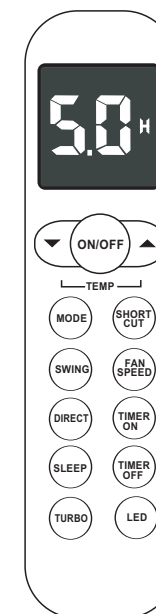

Continue to press **TIMER ON** or **TIMER OFF** button until desired time is reached.

Setting both TIMER ON and TIMER OFF at the same time

Keep in mind that the time periods you set for both functions refer to hours after the current time. For example, suppose that the current time is 1:00 PM, and you want the unit to turn on automatically at 7:00 PM. You want it to operate for 2 hours, then automatically turn off at 9:00 PM.

Do the following:

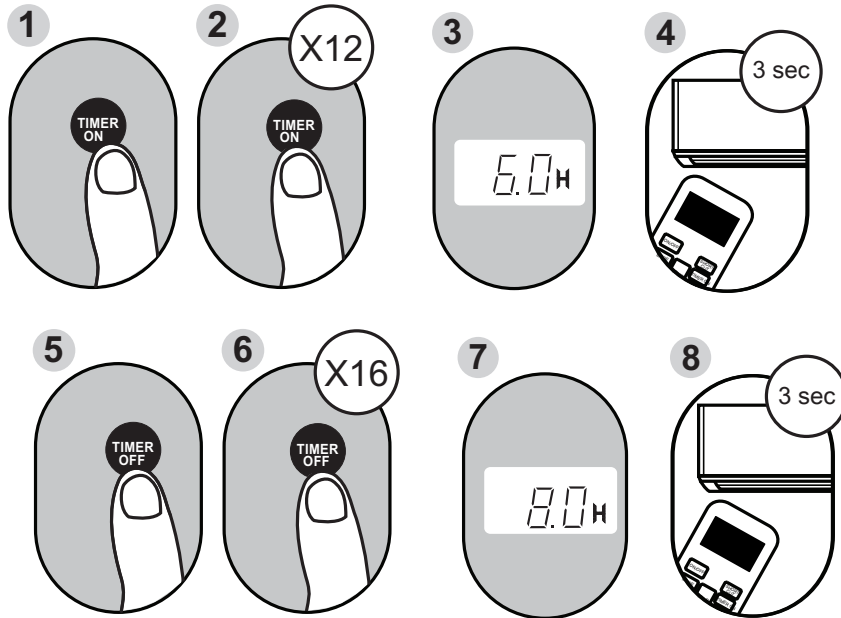

Example: Setting the unit to turn on after 6 hours, operate for 2 hours, then turn off (see the figure below)

Your remote display

