

R **RAMSOND®** **GWi SERIES**

USE AND INSTALLATION INSTRUCTIONS

**27GWi (220v) | 37GWi (220v) | 55GWi (220v) | 74 GWi (220v) | 101GWi (220v)
27SEG (110v) | 37SEG (110v)**

Please read these Use and Installation Instructions carefully and completely before installing and using this appliance. Keep this manual for reference.

Contents

Safety Instructions	1
Preparation before Use	2
Preset	2
Safeguarding the Environment	2
Safety Precautions	3
Identification of Parts	4
Indoor Unit	4
Outdoor Unit	4
Display Introduction	5
Care and Maintenance	7
Protection	8
Energy Saving Tips	9
Troubleshooting	10
Installation Instructions	11
Installation Diagram	11
Suggested Tools	12
Site Instructions	13
Indoor Unit Installation	14
Outdoor Unit Installation	18
Power and Wiring	20
Vacuum Testing and Charging	22
Start-up	23

For full remote control operation instructions, please refer to separate “Remote Control Instructions” manual.

Safety Instructions

- To guarantee the unit work normally, please read the manual carefully before installation, and try to install strictly according to this manual.
- Do not let air enter the refrigeration system or discharge refrigerant when moving the air conditioner.
- Properly ground the air conditioner into the earth.
- Check the connecting cables and pipes carefully, make sure they are correct and firm before connecting the power of the air conditioner.
- There must be an air-break switch.
- After installing, the consumer must operate the air conditioner correctly according to this manual, keep a suitable storage for maintenance and moving of the air conditioner in the future.
- The Fuse of the unit:

Model	Fuse of Indoor unit	Fuse of outdoor unit
9K 27SEG 110V (108~115)	T 3.15A 250V	T 20A 250V
12K 37SEG 110V (108~115)	T 3.15A 250V	T 25A 250V
9K-12K 27GWi/37GWi 220V (208~230V)	T 3.15A 250V	T 15A 250V
18K 55GWi 220V (208~230V)	T 3.15A 250V	T 20A 250V
24K-36K 74GWi/101GWi 220V (208~230V)	T 3.15A 250V	T 30A 250V

- A residual current device(RCD)with the rating of above 10mA shall be incorporated in the fixed wiring according to the national rule
- Warning: Risk of electric shock can cause injury or death: Disconnect all remote electric power supplies before servicing .
- The best length of the connecting pipe between the indoor unit and outdoor unit is less than 7.5 meters(24.6ft). It will affect the efficiency of the air conditioner if the distance longer than that length.
- This appliance can be used by children aged from 8 years and above and persons with reduced physical, sensory or mental capabilities or lack of experience and knowledge if they have been given supervision or instruction concerning use of the appliance in a safe way and understand the hazards involved. Children shall not play with the appliance. Cleaning and user maintenance shall not be made by children without supervision.
- The batteries in remote controller must be recycled or disposed of properly. Disposal of Scrap Batteries --- Please discard the batteries as sorted municipal waste at the accessible collection point.
- If the appliance is fixed wiring, the appliance must be fitted with means for disconnection from the supply mains having a contact separation in all poles that provide full disconnection under overvoltage category III conditions, and these means must be incorporated in the fixed wiring in accordance with the wiring rules.
- If the supply cord is damaged, it must be replaced by the manufacturer, its service agent or similarly qualified persons in order to avoid a hazard.
- The appliance shall be installed in accordance with local electrical safety regulations and National Electrical Codes(NEC).
- The air conditioner must be installed by professional or qualified persons.
- The appliance shall not be installed in the laundry.

Preparation before Use

Note

- When charging refrigerant into the system, make sure to charge in liquid state, if the refrigerant of the appliance is R410A. Otherwise, chemical composition of refrigerant (R410A) inside the system may change and thus affect performance of the air conditioner.
- According to the character of refrigerant (R410A, the value of GWP is 2088), the pressure of the tube is very high, so be sure to be careful when you install and repair the appliance.
- If the supply cord is damaged, it must be replaced by the manufacturer, its service agent or similarly qualified persons in order to avoid a hazard.
- The air conditioner must be installed by trained, qualified installers and service mechanics.
- The temperature of refrigerant circuit will be high, please keep the interconnection cable away from the copper tube.

Preset

Before using the air conditioner, be sure to check and preset the following.

• Remote Control Presetting

Each time after the remote control is replaced with new batteries or is energized, remote control auto presetting heat pump. If the air conditioner you purchased is a Cooling Only one, heat pump remote controller can also be used.

• Back-light Function of Remote Control (optional)

Hold down any button on remote control to activate the back light. It automatically shuts off 10 seconds later.

Note: Back-light is an optional function.

• Auto Restart Presetting

The air conditioner has an Auto-Restart function.

Safeguarding the environment

This appliance is made of recyclable or re-usable material. Scrapping must be carried out in compliance with local waste disposal regulations. Before scrapping it, make sure to cut off the mains cord so that the appliance cannot be re-used.

For more detailed information on handling and recycling this product, contact your local authorities who deal with the separate collection of rubbish or the shop where you bought the appliance.

SCRAPPING OF APPLIANCE

This marking indicates that this product should not be disposed with other household wastes throughout the North America. To prevent possible harm to the environment or human health from uncontrolled waste disposal, recycle it responsibly to promote the sustainable reuse of material resources. To return your used device, please use the return and collection systems or contact the retailer where the product was purchased. They can take this product for environmental safe recycling.



Safety Precautions

Symbols in this Use and Care Manual are interpreted as shown below.



Be sure not to do.























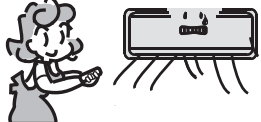

Grounding is essential.

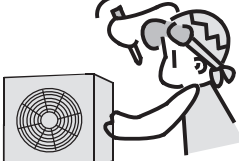

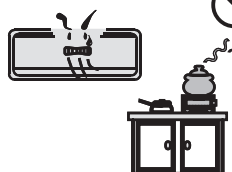
Pay attention to such a situation.

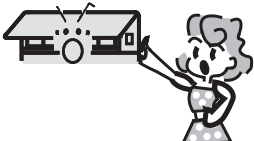

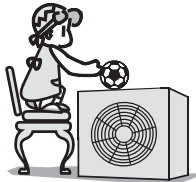
Warning: Incorrect handling could cause a serious hazard, such as death, serious injury, etc.

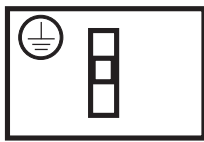
 <p>Use correct power supply in accordance with the rating plate requirement. Otherwise, serious faults or hazard may occur or a fire maybe break out.</p>	  <p>Keep the power supply circuit breaker or plug from dirt. Connect the power supply cord to it firmly and correctly, lest an electric shock or a fire break out due to insufficient contact.</p>	  <p>Do not use the power supply circuit breaker or pull off the plug to turn it off during operation. This may cause a fire due to spark, etc.</p>
  <p>Do not knit, pull or press the power supply cord, lest the power supply cord be broken. An electric shock or fire is probably caused by a broken power supply cord.</p>	  <p>Never insert a stick or similar obstacle to the unit. Since the fan rotates at high speed, this may cause an injury.</p>	  <p>It is harmful to your health if the cool air reaches you for a long time. It is advisable to let the air flow be deflected to all the room.</p>
  <p>Turn off the appliance by remote control firstly before cutting off power supply if malfunction occurs.</p>	  <p>Do not repair the appliance by yourself. If this is done incorrectly, it may cause an electric shock, etc.</p>	  <p>Prevent the air flow from reaching the gas burners and stove.</p>
  <p>Do not touch the operation buttons when your hands are wet.</p>	  <p>Do not put any objects on the outdoor unit.</p>	   <p>It is the user's responsibility to make the appliance be grounded according to local codes or ordinances by a licenced technician.</p>

Identification of Parts

Indoor unit

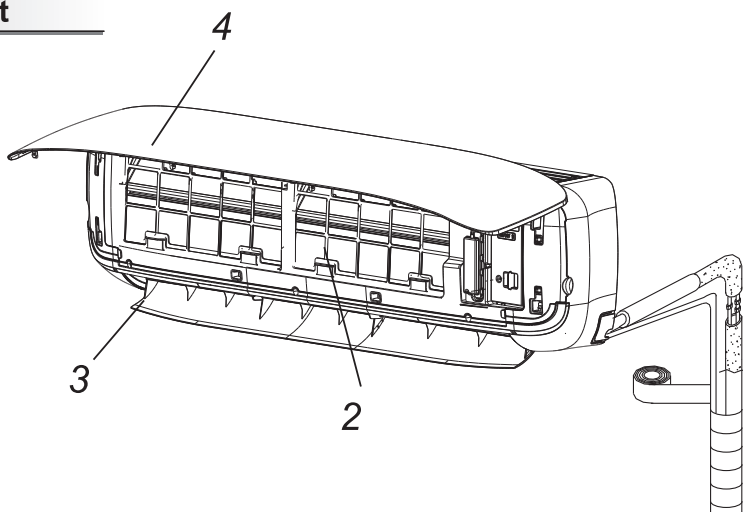

Part Name



1. Remote Controller

2. Air Filter

3. Horizontal Louvers

4. Front Panel

5. Pipes and Power Connection Cord

6. Drain Hose

Outdoor unit

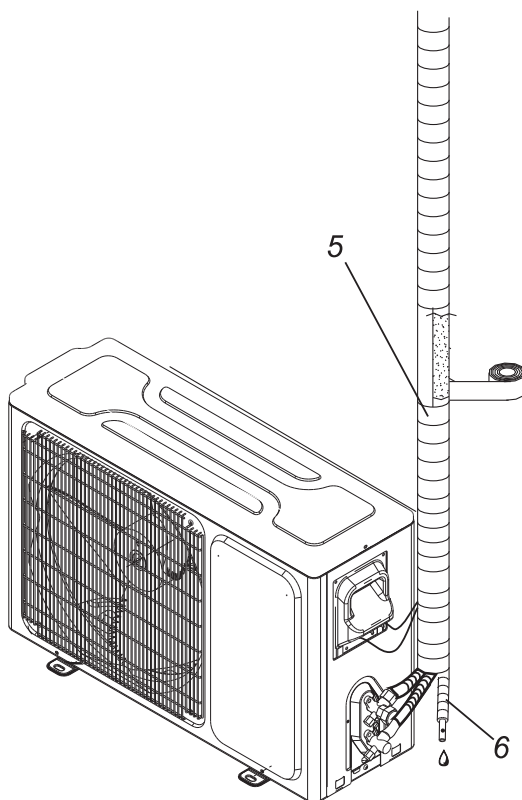

☑ The figures in this manual are based on the external view of a standard model. Consequently, the shape may differ from that of the air conditioner you have selected.

Display Introduction

	<p>Temperature indicator ----- 1</p> <p>Display set temperature. It shows FC after 200 hours of usage as reminder to clean the filter. After filter cleaning press the filter reset button located on the indoor unit behind the front panel in order to reset the display. (optional)</p>
	<p>Running indicator ----- 2</p> <p>It lights up when the AC is running. It flashes during defrosting.</p>
	<p>Timer indicator ----- 3</p> <p>It lights up during set time.</p>
	<p>Sleep indicator ----- 4</p> <p>It lights up in sleep mode.</p>
	<p>Compressor indicator ----- 5</p> <p>It lights up when the compressor is on.</p>
	<p>Super indicator ----- 6</p> <p>It lights up in super mode.</p>
	<p>Mode indicator ----- 7</p> <p>Heating displays orange, others display white</p>
	<p>Fan speed indicator ----- 8</p>
	<p>Signal Receptor ----- 9</p>

The symbols may be different from these models, but the functions are similar.

Display Introduction

GWi Series Display

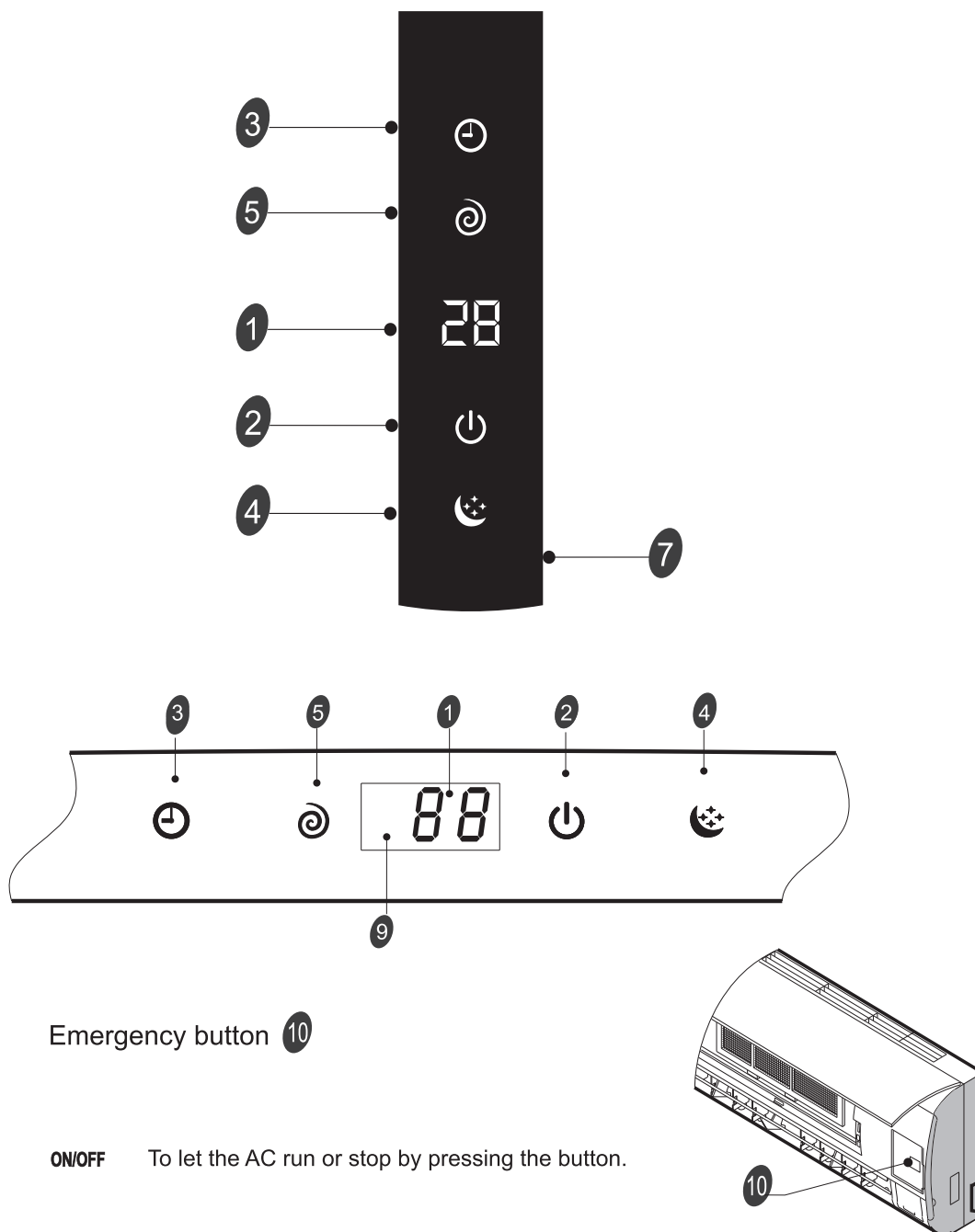

Emergency button 10

ON/OFF To let the AC run or stop by pressing the button.

☑ *The symbols may be different from these models, but the functions are similar.*

Care and Maintenance

Front panel maintenance

1 Cut off the power supply

Turn off the appliance first before disconnecting from power supply.

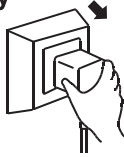

2

Grasp position "a" and pull outward to remove the front panel.

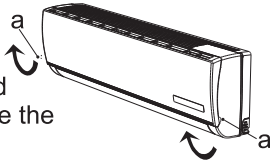

3 Wipe with a soft and dry cloth.

Use soft moisture cloth to clean if the front panel is very dirty.



Use a dry and soft cloth to clean it.

4

Never use volatile substance such as gasoline or polishing powder to clean the appliance.



5

Never sprinkle water onto the indoor unit



Dangerous!
Electric shock!

6

Reinstall and shut the front panel.

Reinstall and shut the front panel by pressing position "b" downward.



Air filter maintenance

It is necessary to clean the air filter after using it for about 200 hours.

Clean it as follows:

1 Stop the appliance and remove the air filter.

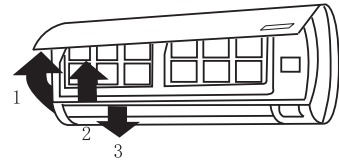

1. Open the front panel.
2. Press the handle of the filter gently from the front.
3. Grasp the handle and slide out the filter.

2

Clean and reinstall the air filter.

If the dirt is conspicuous, wash it with a solution of detergent in lukewarm water. After cleaning, dry well in shade.



3

Close the front panel again.

- ☑ *Clean the air filter every two weeks if the air conditioner operates in an extremely dusty environment.*

Protection

Operating condition

The protective device maybe trip and stop the appliance in the cases listed below.

HEATING	Outdoor air temperature is over 75°F(24°C)
	Outdoor air temperature is below 5°F(-15°C)
	Room temperature is over 80.6°F(27°C)
COOLING	Outdoor air temperature is over *115°F(46°C)
	Room temperature is below 70°F(21°C)
DRY	Room temperature is below 64.5°F(18°C)

**For Tropical (T3) Climate condition models, the temperature point is 131°F(55°C) instead of 109°F(43°C). The temperature of some products is allowed beyond the range. In specific situation, please consult the merchant.
If the air conditioner runs in COOLING or DRY mode with door or window opened for a long time when relative humidity is above 80%,dew may drip down from the outlet.*

Noise pollution

- Install the air conditioner at a place that can bear its weight in order to operate more quietly.
- Install the outdoor unit at a place where the air discharged and the operation noise would not annoy your neighbors.
- Do not place any obstacles in front of the air outlet of the outdoor unit lest it increases the noise level.

Features of protector

The protective device will work at following cases.

- ① Restarting the unit at once after operation stops or changing mode during operation, you need to wait 3 minutes.
- ② If all operation has stopped, press **ON/OFF** button again to restart, Timer should be set again if it has been canceled.

Features of HEATING mode

Preheat

At the beginning of the HEATING operation, the airflow from the indoor unit is discharged 2-5 minutes later.

Defrost

In **HEATING** operation the appliance will defrost (de-ice) automatically to raise efficiency. This procedure usually lasts 2-10 minutes. During defrosting, fans stop operation. After defrosting completes, it returns to **HEATING** mode automatically.

Note: Heating is NOT available for cooling only air conditioner models.

Energy Saving Tips

1. Relaxing room temperature at night is OK: During the nighttime hours you don't require the same level of conscious cooling or heating. Try using Sleep mode to gradually relax room temperature and allow the unit to run less and save energy.

2. Curtains and shades: In the summer, you need to block the effects of the sun. Close window curtains and shades on the south and west side of your home to help block solar heat. In winter, the sun is your friend. Open curtains and shades to allow solar heat into your room.

3. Close doors: If you don't need to heat and cool your whole home, confine the heating and cooling to one room by closing doors. Limit the space you're heating and cooling to specified capability of the unit.

4. Service the unit: Some basic maintenance might be all you need. The outdoor unit will greatly benefit from a good hosing out, especially in treed areas where seeds and other debris can stick to coil fins and make the unit work harder!

5. Rearrange the room: Furniture that obstructs airflow means you could be heating and cooling the back of a chair or the front of a sofa instead of the actual living space. Use the swing louvers to help direct the air in the right direction for the room; remove or rearrange obstacles blocking airflow.

6. Try 75 degrees: 75°F(24°C) is a good point for an air conditioner to run at its optimal performance level. Even a 1-degree change in temperature can make your unit use more energy!

7. Lighting: Turning lights off can help reduce your heat. Each light bulb is a tiny heater. Your air conditioner must waste energy overcoming the heat from your lights to reach and hold your desired room temperature.

8. Is anyone home? If possible, while you're away turn your unit to Auto mode and make sure windows and drapes are closed. Although the room temperature will be uncomfortable for a few minutes when you come home, the unit will have the room back to your desired temperature in no time.

9. Don't forget the fan: The fan is much like a car. The faster it runs, the more energy is consumed. Sometimes we need the car to go fast, but slow is good enough most of the time. Try saving money by using the comfortable quiet low fan speed as much as possible.

Troubleshooting

The following cases may not always be a malfunction, please check it before asking for service.

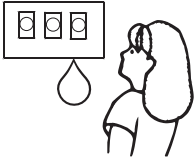
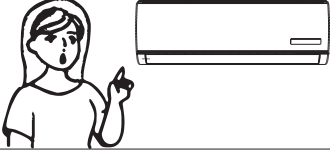
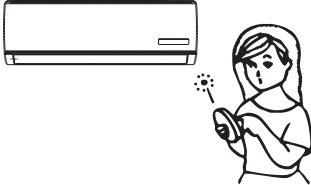
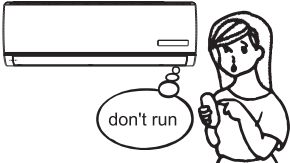
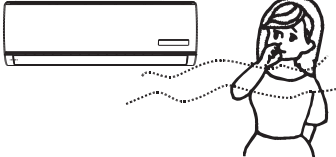
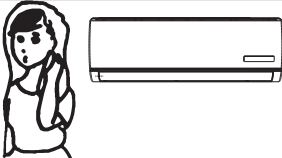
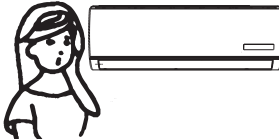
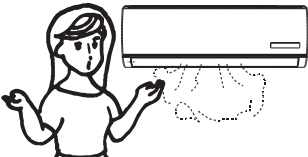
Trouble	Analysis
<p>Does not run</p> 	<ul style="list-style-type: none"> • If the protector trip or fuse is blown, please wait 3 minutes and start again. The protector device may be preventing unit from working. • The batteries in the remote control may be dead • Check to see if the appliance is properly plugged in.
<p>No cooling or heating air</p> 	<ul style="list-style-type: none"> • Is the air filter dirty? • Are the intakes and outlets of the air conditioner blocked? • Is the temperature set properly? • Are doors or windows open?
<p>Ineffective control</p> 	<ul style="list-style-type: none"> • If there is strong interference (from excessive static electricity discharge or power supply voltage abnormality), the appliance may operate abnormally. Disconnect the power supply and connect back 2-3 seconds later.
<p>Does not operate immediately</p> 	<ul style="list-style-type: none"> • Changing mode during operation, 3 minutes will delay.
<p>Peculiar odor</p> 	<ul style="list-style-type: none"> • This odor may come from another source such as furniture, cigarette etc, which is sucked in the unit and blows out with the air.
<p>A sound of flowing water</p> 	<ul style="list-style-type: none"> • Caused by the flow of refrigerant in the air conditioner. Not a cause for concern. • Sound of defrosting during heating mode.
<p>Cracking sound is heard</p> 	<ul style="list-style-type: none"> • The sound may be generated by the expansion or contraction of the front panel due to change of temperature.
<p>Spraying mist from the outlet</p> 	<ul style="list-style-type: none"> • Mist appears when the air in the room becomes very cold. This is because of the cool air discharged from the indoor unit during COOLING or DRY modes.
<p>The compressor indicator lights on constantly, running indicator flashes and indoor fan stops.</p>	<ul style="list-style-type: none"> • The unit is shifting from heating mode to defrost. The indicator will light off and return to heating mode.

Installation Instructions

Installation diagram

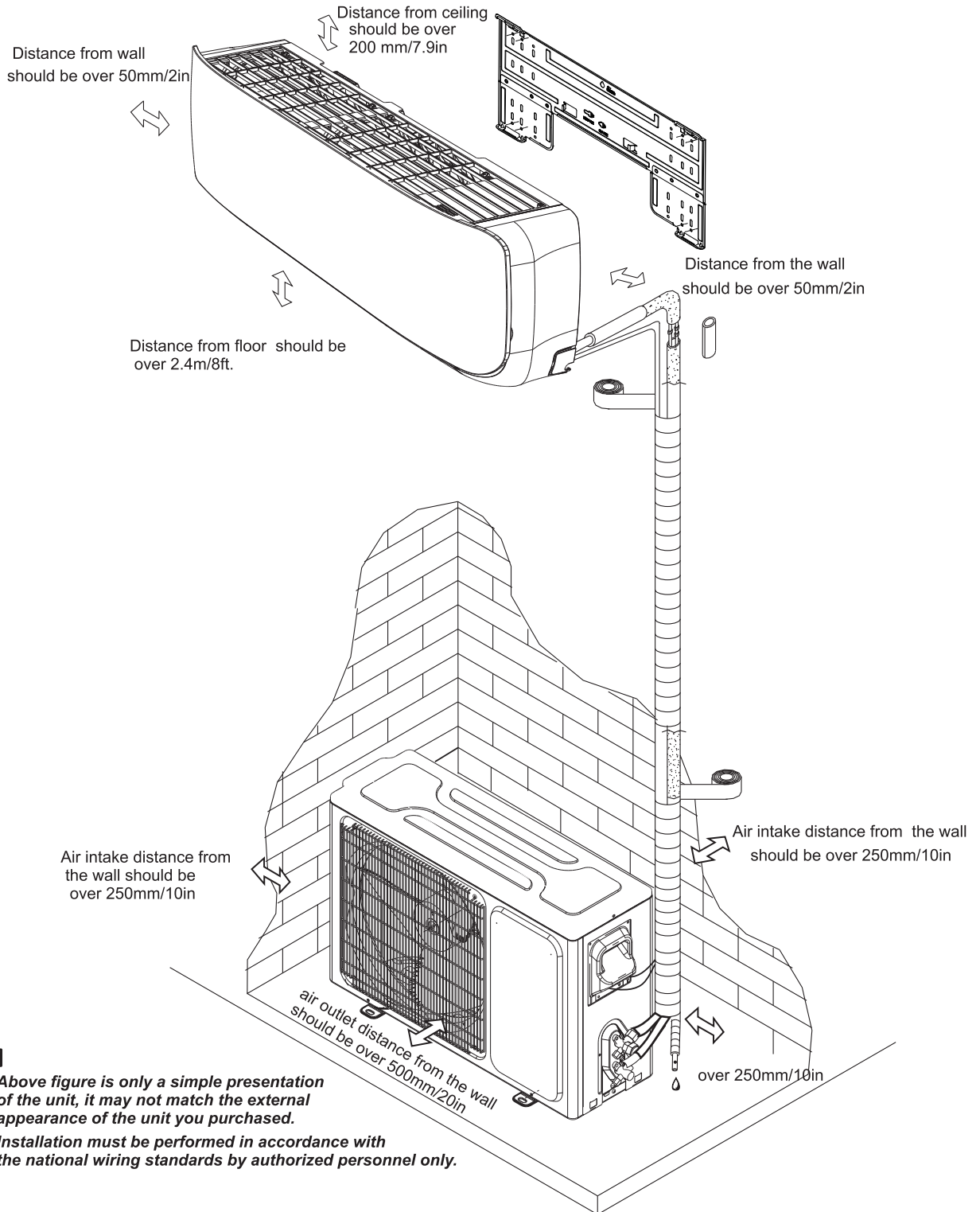

- Above figure is only a simple presentation of the unit, it may not match the external appearance of the unit you purchased.
- Installation must be performed in accordance with the national wiring standards by authorized personnel only.

Installation Instructions

Suggested Tools

In order to install your air-conditioner more conveniently and safely, you might use those special tools listed below.



Standard Wrench



Screw Driver



Hex Keys or Allen Wrenches



Adjustable/Crescent Wrench



Torque wrench



Drill & Drill Bits



Manifold and Gauges



Vacuum Pump



Clamp on Amp Meter



Level

Work Gloves

Safety Glasses

Pipe Cutter

Refrigerant Scale

R410A Flaring Tool

Micron Gauge

Hole Saw



Installation Instructions

Site Instructions

Site for Installing Indoor Unit

- Where there is no obstacle near the air outlet and air can be easily blown to every corner.
- Where piping and wall hole can be easily arranged.
- Keep the required space from the unit to the ceiling and wall according to the installation diagram on previous page.
- Where the air filter can be easily removed.
- Keep the unit and remote controller 1m(3.28ft) or more apart from television, radio etc.
- keep as far as possible from fluorescent lamps.
- Do not put anything near the air inlet to obstruct it from air absorption.
- Install on a wall that is strong enough to bear the weight of the unit.
- Install in a place that will not increase operation noise and vibration.
- Keep away from direct sunlight and heating sources. Do not place flammable materials or combustion apparatuses on top of the unit.

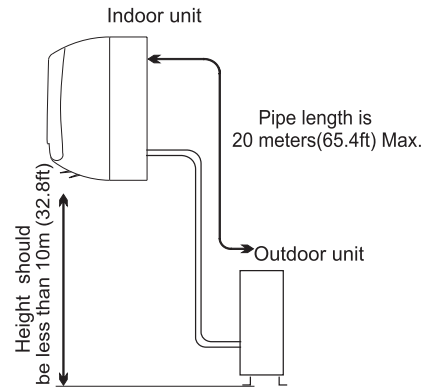

Indoor unit is higher than outdoor unit

Site for Installing Outdoor Unit

- Where it is convenient to install and well ventilated.
- Avoid installing it where flammable gas could leak.
- Keep the required distance apart from the wall.
- Keep the outdoor unit away from greasy dirt, vulcanization gas exit.
- Avoid installing it by the roadside where there is a risk of muddy water.
- A fixed base where it is not subject to increased operation noise.
- Where there is not any blockage of the air outlet.
- Avoid installing under direct sunlight, in an aisle or sideway, or near heat sources and ventilation fans. Keep away from flammable materials, thick oil fog, and wet or uneven places.
- In case the pipe length is more than 7.5m(24.6ft), the refrigerant should be charged additionally, according to below table.

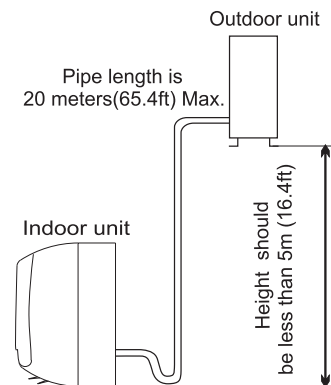

Outdoor unit is higher than indoor unit

Model	Required amount of additional refrigerant (g/m)
9000Btu-18000Btu	20
24000Btu	30
30000Btu-36000Btu	40

If the height or pipe length is out of the scope of the table, please consult the merchant.

Installation Instructions

Indoor unit installation

1. Installing the Mounting Plate

- Decide an installing location for the mounting plate according to the indoor unit location and piping direction.

Note: it is recommended to install screw anchors for sheet rock, concrete block, brick and such type of wall.

- Keep the mounting plate horizontal with a horizontal level or dropping line.
- Mark the center of the indoor unit on mounting plate for future reference.

Note: the center of the mounting bracket may be not the center of the indoor unit.

- Tapping mounting plate to the wall with a minimum of five screws, evenly spaced to properly support indoor unit weight.

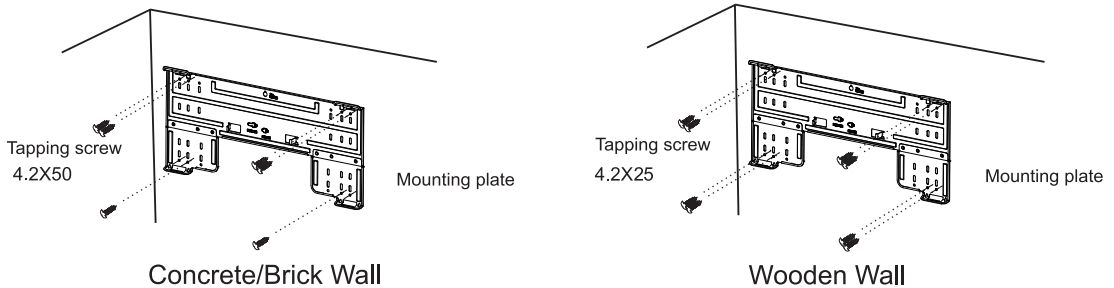

Note: The shape of your mounting plate may be different from the one above, but the installation method is similar.

Note: As the above figure shown, the six holes matched with tapping screw on the mounting plate must be used to fix the mounting plate, the others are prepared.

MOUNTING BRACKET DIAGRAMS AND DIMENSIONS (Recommended)

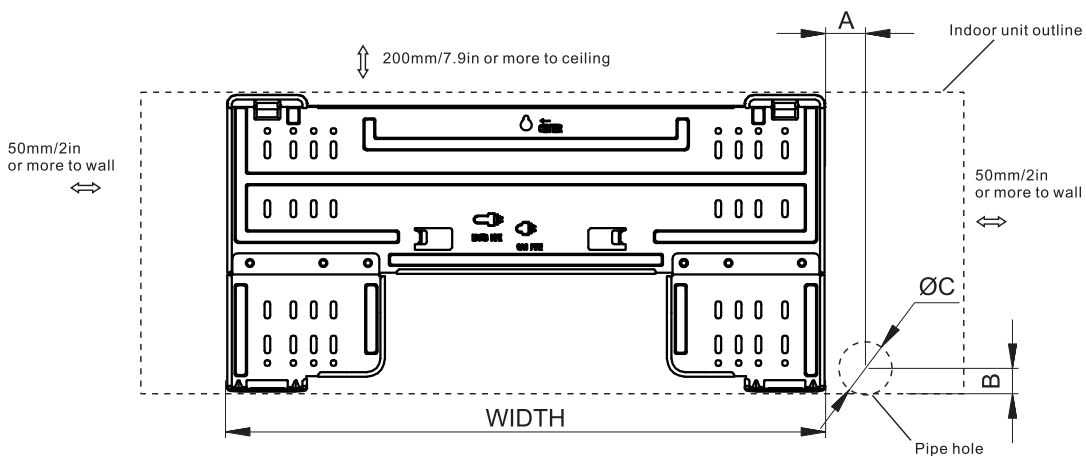

For 9000Btu SEER16 Series Model, WIDTH:522mm/20.6in
For 12000Btu SEER16 Series Model, WIDTH:592mm/23.3in

Installation Instructions

Indoor unit installation

MOUNTING BRACKET DIAGRAMS AND DIMENSIONS (Recommended)

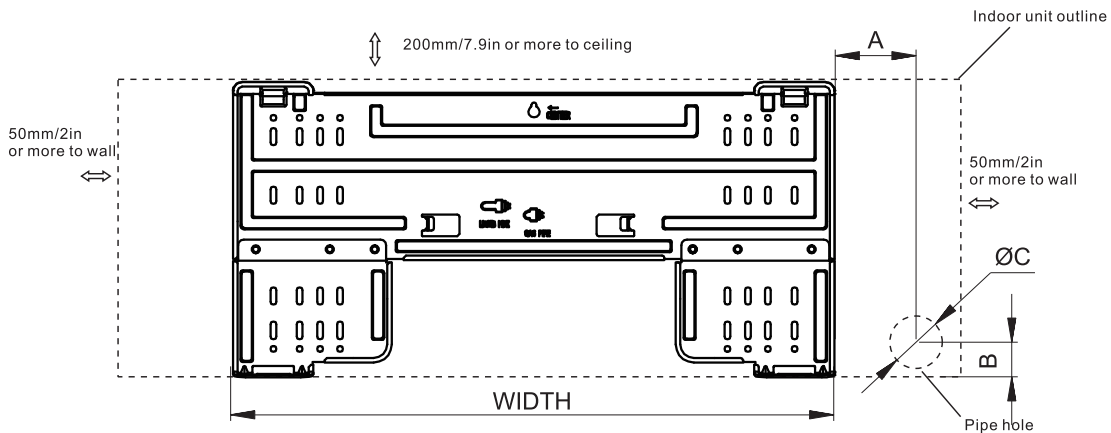

For 18000/24000Btu SEER16 Series Model, WIDTH: 629mm/24.8in

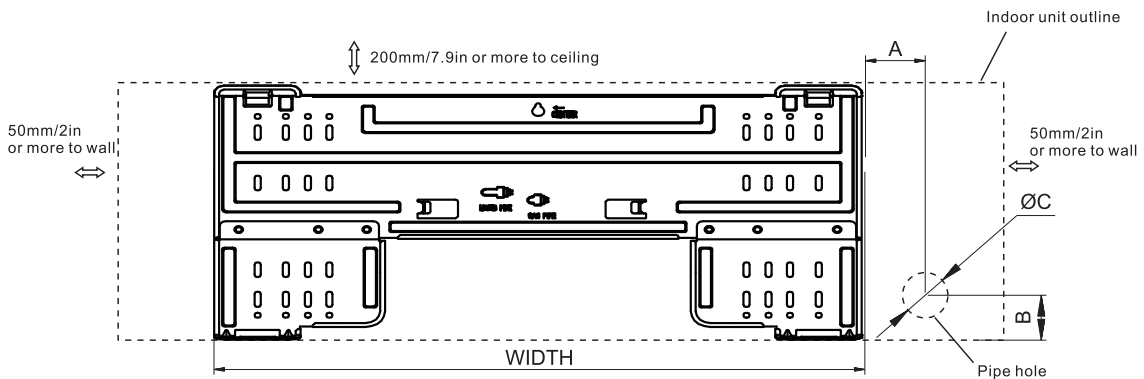

For 30000Btu-36000Btu SEER16 Series Model, WIDTH: 820mm/32.3in

Installation Instructions

Indoor unit installation

2. Drill a Hole in wall for interconnecting Piping, Drain & Wiring

- Decide the position of the hole for piping according to the location of mounting plate.
- Drill a hole in the wall. The hole should tilt a little downward toward outside.
- Install a sleeve through the wall hole to keep the wall tidy and clean.

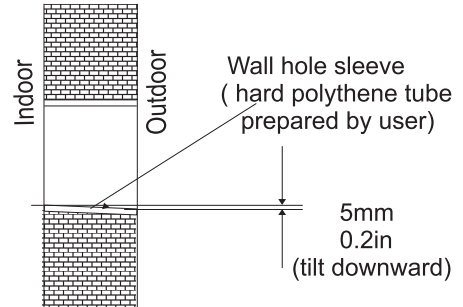
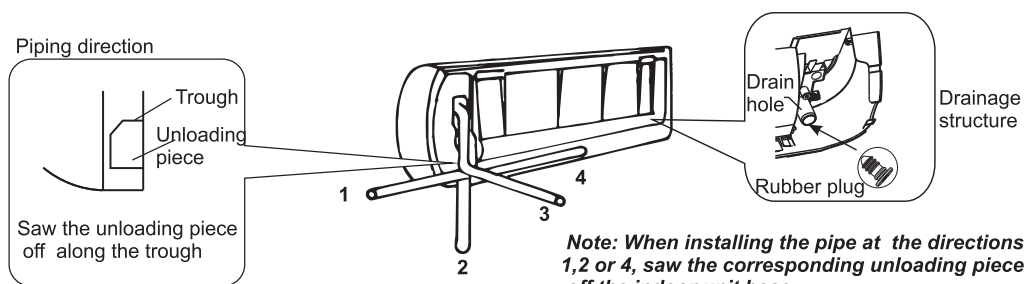

Table of Wall Hole Mounting size per Unit Size

Unit Model	Size A	Size B	Size C
	mm/in	mm/in	mm/in
9000Btu SEER16 Series	68/2.68	33/1.3	70/2.7
12000Btu SEER16 Series	70/2.75	35/1.38	70/2.7
18000Btu SEER16 Series	137/5.4	40/1.57	70/2.7
24000Btu SEER16 Series	170/6.7	40/1.57	70/2.7
30000Btu -36000Btu SEER16 Series	64/2.52	41.2/1.62	70/2.7

3. Piping and Drain Hose Connections to Indoor Unit

- Put the piping (liquid and gas pipe) and cables through the wall hole from outside or put them through from inside after indoor piping and cables connection is complete to connect to the outdoor unit.
- Decide whether to saw the unloading piece off in accordance with the piping direction.(as shown below)



- After connecting the piping, install the drain hose. Then connect the power cords. After connecting, wrap the piping, cords and drain hose together with thermal insulation materials.

Note: Both sides drainage structure is standard. For both sides drainage structure, it can be chosen for right, left or both sides drainage connection. If choosing both sides drainage connection, another proper drain hose is needed as there is only one drain hose offered by factory. If choosing one side drainage connection, make sure the drain hole on the other side is well plugged.

Installation Instructions

Indoor unit installation

- **Piping Joints Thermal Insulation:**

Wrap the piping joints with thermal insulation materials and then wrap with a vinyl tape.

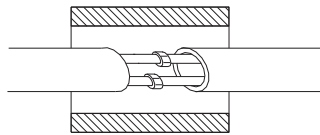

Thermal insulation

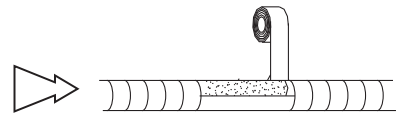

wrapped with vinyl type

- **Piping Thermal Insulation:**

- Place the drain hose under the piping.
 - Insulation material uses polythene foam over 6mm in thickness.
- Note: Drain hose is prepared by user.**

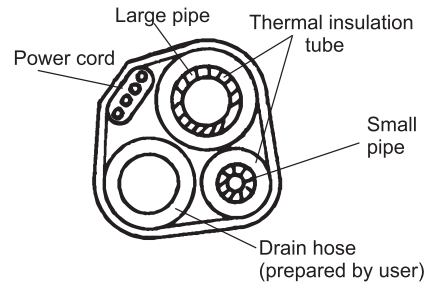

- Do not arrange the drain pipe in a way that leaves it twisted, sticking out or waving around. Do not immerse the end of it in water.
- If an extension drain hose is connected to the drain pipe, make sure to insulated when passing along the indoor unit.
- When the piping is directed to the right, piping, power Cord and drain pipe should be thermal insulated and fixed onto the back of the unit with a piping fixer.

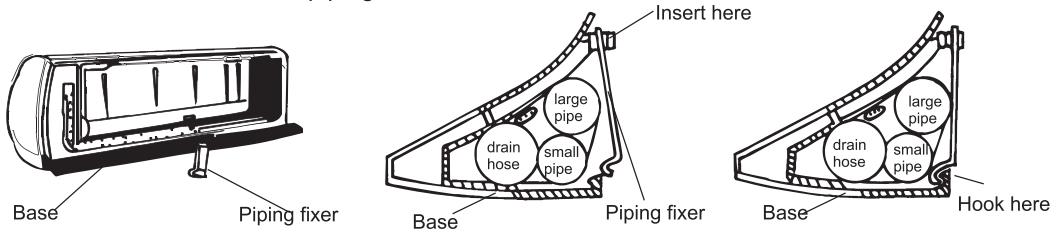

A. Insert the pipe fixer to the slot.

B. Press to hook the pipe fixer onto the base.

Piping Connection:

- Connect indoor unit pipes with two wrenches. Pay special attention to the allowed torque as shown below to prevent the pipes, connectors and flare nuts from being deformed and damaged.
- Pre-tighten them with fingers at first, then use the wrenches.

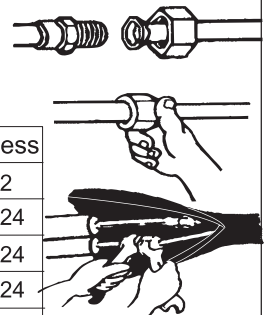

Model	Pipe size	Torque	Nut width	Min.thickness
9000Btu-18000Btu	Liquid Side (ϕ 6 or 1/4)	15~20N·m or 11~15ft-lbs	17 or 5/8	0.5 or 0.02
24000Btu-36000Btu	Liquid Side (ϕ 9.53 or 3/8)	30~35N·m or 22~26ft-lbs	22 or 7/8	0.6 or 0.024
9000Btu-12000Btu	Gas Side (ϕ 9.53 or 3/8)	30~35N·m or 22~26ft-lbs	22 or 7/8	0.6 or 0.024
18000Btu	Gas Side (ϕ 12 or 1/2)	50~55N·m or 37~41ft-lbs	24 or 0.94	0.6 or 0.024
24000Btu-36000Btu	Gas Side (ϕ 16 or 5/8)	60~65N·m or 44~48ft-lbs	27 or 1.1	0.6 or 0.024

NOTE:

Dimensions are in "mm or inch" unless otherwise stated in the table.

Installation Instructions

Outdoor Unit Installation

1. Install Condensate Drain for Outdoor Unit

The condensate drains from the outdoor unit when the unit operates in heating mode. In order not to disturb your neighbor and protect the environment, install a drain port and a drain hose to direct the condensate water. Just install the drain port and rubber washer to the chassis of the outdoor unit, then connect a drain hose to the port as the right figure demonstrates.

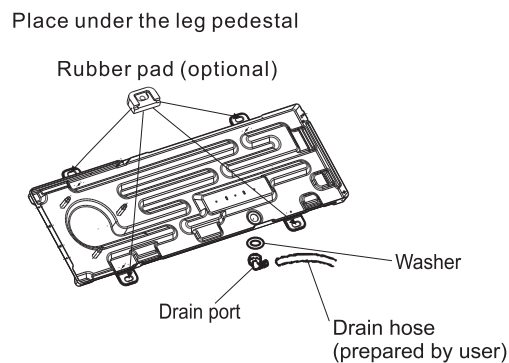

2. Install Ground Pad or Wall Hangers

1. Determine proper location for outdoor unit.
 2. Follow all instructions provided by manufacturer for installing wall hangers rubber pad.
 3. Verify the wall hangers or rubber pad can safely support the weight of the outdoor unit.
 4. Verify the wall hangers or rubber pad is level and meets all outdoor dimensional clearance.
 5. Fix with bolts and nuts tightly on a flat and strong floor.
- If installed on the wall or roof, make sure to fix the supporter well to prevent it from shaking due to serious vibration or strong wind.

WARNING

Florida wind load requirements state that outdoor unit must be anchored to concrete pad using four 3/8-in diameter power wedge bolt plus (or equivalent) with 1-in diameter fender washers. Anchor bolts must be embedded into 3000 PSI minimum concrete at a distance of 4 1/2- in from any concrete edge. The concrete thickness must exceed 1.5 times the anchor depth.

Installation Instructions

3. Piping Connections to Outdoor Unit

- Remove service valve cover(if provided) to access the service valves and refrigerant ports.
- Carefully bend and adjust length of refrigerant pipes to meet outdoor unit service valves connection with proper tools to avoid kinks.
- Apply a small amount of refrigerant oil to the flare connection on the refrigerant pipe.
- Properly align piping and tighten flare nut using a standard wrench and a torque wrench as shown in the indoor piping section.
- Carefully tighten flare nuts to correct torque level referring to the following Torque Table:

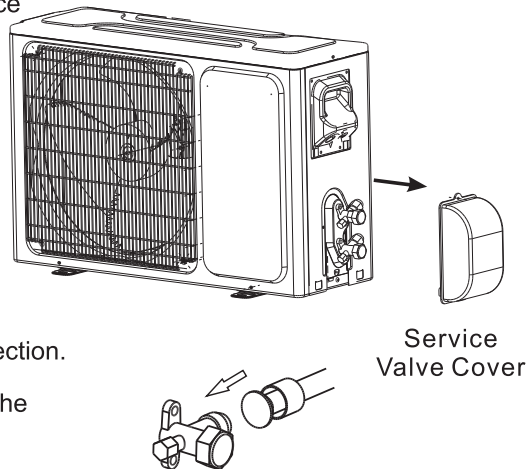

Torque Table

Pipe diameter /inch(mm)	Nut Size /inch(mm)	Tightening Torque	
		ft-lbs	N-m
1/4(6.35)	1/4(17)	11 to 15	15 to 20
3/8(9.5)	3/8(22)	22 to 26	30 to 35
1/2(12.7)	1/2(25)	37 to 41	50 to 55
5/8(15.9)	5/8(29)	44 to 48	60 to 65

Note: Over tightening may damage flare connections and cause leaks.

Installation Instructions

Power and Wiring

Connecting of the Cable

Indoor Unit

Connect the power cord to the indoor unit by connecting the wires to the terminals on the control board individually in accordance with the outdoor unit connection.

Note: For some models, it is necessary to remove the cabinet to connect to the indoor unit terminal.

Outdoor Unit

1) Remove the cable cross board from the unit by loosening the screw. Connect the wires to the terminals on the control board individually as follows.

2) Secure the power cord onto the control board with cable clamp.

3) Reinstall the cable cross board to the original position with the screw.

4) Use a recognized circuit breaker between the power source and the unit. A disconnecting device to adequately disconnect all supply lines must be fitted.

Caution:

1. Never fail to have an individual power circuit specifically for the air conditioner. As for the method of wiring, refer to the circuit diagram posted on the inside of the access door .
2. Confirm that the cable thickness is as specified in the power source specification.
3. Check the wires and make sure that they are all tightly fastened after cable connection.
4. Be sure to install an earth leakage circuit breaker in wet or moist areas.

Cable Specifications

capacity(Btuh)	Power cord		Power connecting cord	
	Type	Normal cross-sectional areas	Type	Normal cross-sectional areas
9K-12K (208/230V)	SJ TW	3X16 AWG	SJ TW	4X18 AWG
18K-24K (208/230V)	SJ TW	3X14 AWG	SJ TW	4X18 AWG
24K-36K (208/230V)	SJ TW	3X12 AWG	SJ TW	4X18 AWG
9K (115V)	SJ TW	3X14 AWG	SJ TW	4X18 AWG
12K (115V)	SJ TW	3X12 AWG	SJ TW	4X18 AWG

Attention:

The plug must be accessible even after the installation of the appliance in case there is a need to disconnect it. If not possible, connect appliance to a double-pole switching device with contact separation of at least 3 mm² placed in an accessible position even after installation.

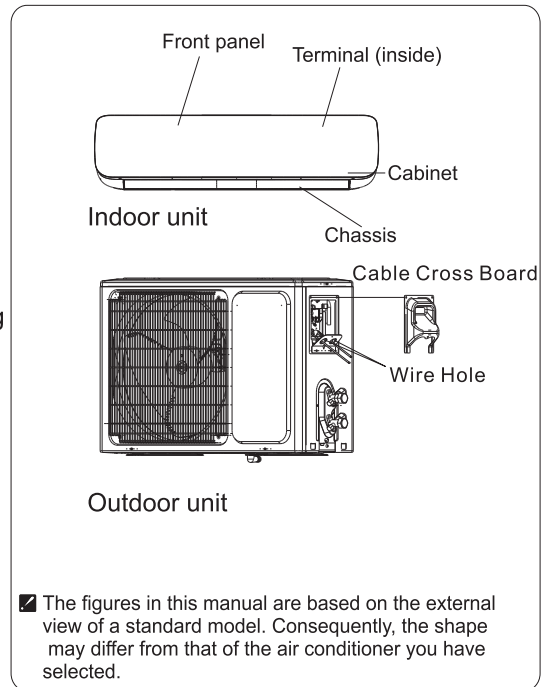

Installation Instructions

Wiring diagram

Make sure that the color of the wires in the outdoor unit and terminal No. are the same as those of the indoor unit.

1) 208/230V

Indoor unit
Terminal

Outdoor unit
Terminal

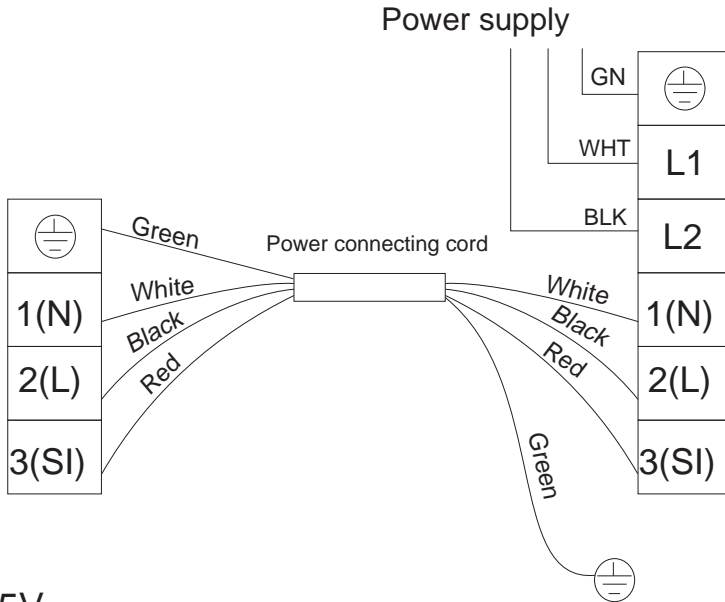

2) 115V

Indoor unit
Terminal

Outdoor unit
Terminal

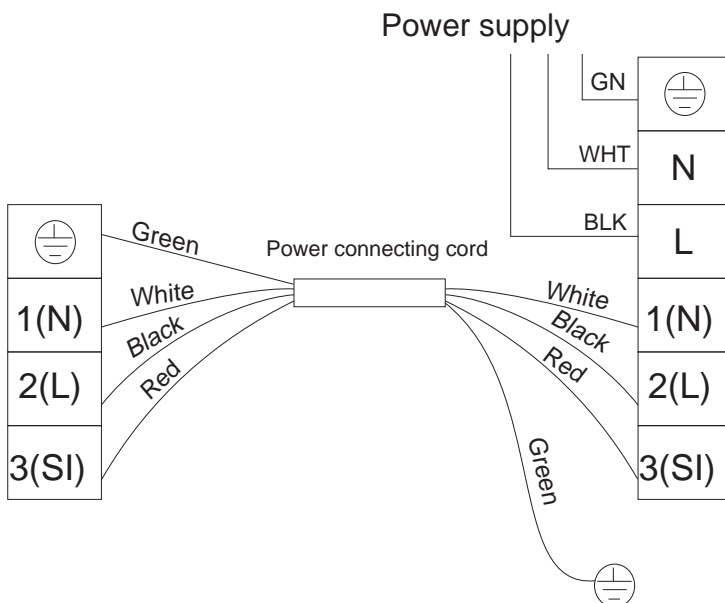

☑ The diagram is reference only, actual terminal may vary in appearance.

Installation Instructions

Start-up

Test Operation

Perform test operation after completing gas leak and electrical safety check.

1. Turn on electrical disconnect to outdoor unit.
2. Push the "ON/OFF" button on Remote Controller to begin testing.
3. Push MODE button, select COOLING, HEATING, FAN mode to confirm all functions.

System Checks

1. Conceal refrigerant pipes where possible.
2. Make sure drain hose slopes downward along entire length.
3. Ensure all refrigerant pipes and connections are properly insulated.
4. Fasten pipes to outside wall, when possible.
5. Seal and weatherproof wall hole which the interconnecting wires and refrigerant pipes pass through.

Indoor Unit

1. Do all Remote controller's buttons function properly?
2. Do the display panel lights work properly?
3. Does the swing louver function properly?
4. Does the drain work?

Outdoor Unit

1. Push the mode button to COOL and adjust the room setting to 61 °F(16°C) deg. wait up to 3 minutes from compressor time guard. Does compressor and outdoor fan turn on in cooling mode?
2. Push the mode button to HEAT and adjust the room setting to 85 °F(30°C) deg. wait up to 3 minutes for compressor time guard. Does compressor and outdoor fan turn on in heat mode?